



Error codes list

Models: AFI/AOU-53HRDC1A
AFI/AOU-71HRDC1A
AFI/AOU-105HRDC3A
AFI/AOU-140HRDC3A
AFI/AOU-180HRDC3A



Contents

1.	Safety Caution	3
2.	General Troubleshooting	4
3.	Information Inquiry	6
4.	Error Diagnosis and Troubleshooting Without Error Code.....	13
4.1	Remote maintenance.....	13
4.2	Field maintenance	14
5.	Quick Maintenance by Error Code.....	19
6.	Troubleshooting by Error Code.....	20
6.1	EH 00/EH 0A / EC 51 (EEPROM parameter error Diagnosis and Solution).....	20
6.2	EL 01 (Indoor and outdoor unit communication error Diagnosis and Solution)	21
6.3	EH 03 / EC 07 (Fan speed is operating outside of the normal range)/EC 71(Over Current Failure of Outdoor DC Fan Motor) Diagnosis and Solution.....	23
6.4	EH 60/EH 61/EC 53/EC 52/EC 54/EC 56/EC 50 (Open circuit or short circuit of temperature sensor diagnosis and solution)	27
6.5	EL 0C (Refrigerant Leakage Detection Diagnosis and Solution)	28
6.6	EH 0E (Water-Level Alarm Malfunction Diagnosis and Solution).....	29
6.7	PC 00 (IPM Malfunction or IGBT Over-strong Current Protection Diagnosis and Solution).....	30
6.8	PC 01 (Over Voltage or Too Low Voltage Protection)/PC 10(Outdoor unit low AC voltage protection)/PC 11(Outdoor unit main control board DC bus high voltage protection)/PC 12(Outdoor unit main control board DC bus high voltage protection /341 MCE error) Diagnosis and Solution.....	31
6.9	PC 04 (Inverter Compressor Drive Error Diagnosis and Solution).....	32

Troubleshooting

Contents

6.10	PC 03/PC 31 (Low Pressure Protection Diagnosis and Solution)	33
6.11	PC 02 (Top temperature protection of compressor or High temperature protection of IPM module Diagnosis and Solution)	34
6.12	EC 0d (Outdoor unit malfunction Diagnosis and Solution).....	35
6.13	PC 40(Communication error between outdoor main PCB and IPM board diagnosis and solution)	36
6.14	PC 08(Current overload protection)/PC 44(Outdoor unit zero speed protection)/PC 46(Compressor speed has been out of control)/PC 49(Compressor overcurrent failure) diagnosis and solution	37
6.15	PC 0F(PFC module protection diagnosis and solution)	39
6.16	EC 72 (Lack phase failure of outdoor DC fan motor diagnosis and solution).	40
6.17	PC 43 (Outdoor compressor lack phase protection diagnosis and solution)...	41
6.18	PC 45 (Outdoor unit IR chip drive failure diagnosis and solution).....	42
6.19	PC 0L (Low ambient temperature protection).....	42
6.20	PC 30 (High pressure protection diagnosis and solution)	43
6.21	PC 0A (High temperature protection of condenser diagnosis and solution)...	45
6.22	PC 06 (Discharge temperature protection of compressor diagnosis and solution) 46	
7.	Check Procedures.....	47

1. Safety Caution

! WARNING

Be sure to turn off all power supplies or disconnect all wires to avoid electric shock. While checking indoor/outdoor PCB, please equip oneself with antistatic gloves or wrist strap to avoid damage to the board.

! WARNING

Electricity remains in capacitors even when the power supply is off. Ensure the capacitors are fully discharged before troubleshooting.

Test the voltage between P and N on back of the main PCB with multimeter. If the voltage is lower than 36V, the capacitors are fully discharged.

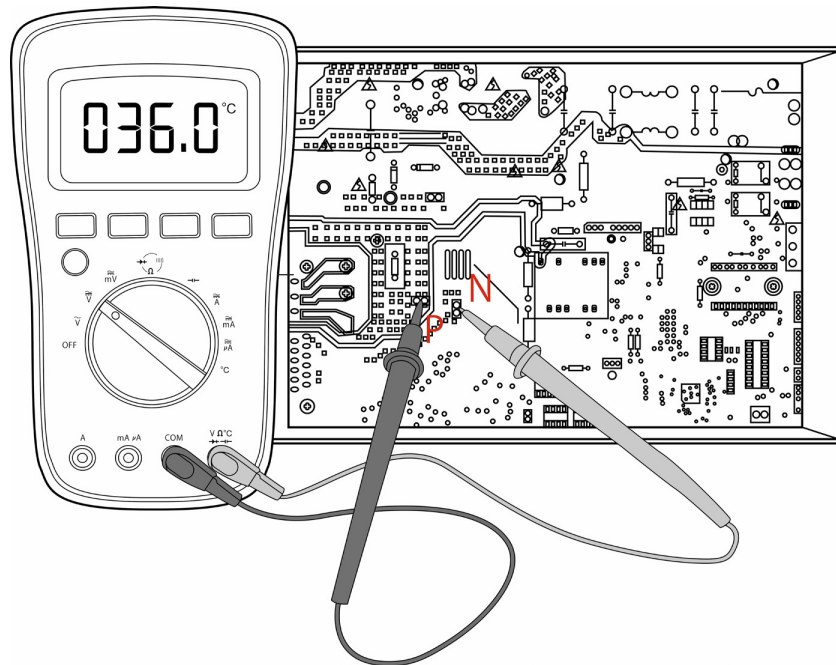

Note: This picture is for reference only. Actual appearance may vary.

2. General Troubleshooting

2.1 Error Display (Indoor Unit)

When the indoor unit encounters a recognized error, the operation lamp will flash in a corresponding series, the timer lamp may turn on or begin flashing, and an error code will be displayed. These error codes are described in the following table:

Operation Lamp	Timer Lamp	Display	Error Information	Solution
1 time	OFF	EH 00/ EH 0R	Indoor unit EEPROM parameter error	TS20
2 times	OFF	EL 01	Indoor / outdoor unit communication error	TS21
4 times	OFF	EH 03	The indoor fan speed is operating outside of the normal range(for some models)	TS23
6 times	OFF	EH 60	Indoor room temperature sensor T1 is in open circuit or has short circuited	TS27
6 times	OFF	EH 61	Evaporator coil temperature sensor T2 is in open circuit or has short circuited	TS27
8 times	OFF	EL 0C	Refrigerant Leakage Detection(for some models)	TS27
13 times	OFF	EH 0E	Water-level alarm malfunction	TS29
5 times	OFF	EC 53	Outdoor room temperature sensor T4 is in open circuit or has short circuited	TS27
5 times	OFF	EC 52	Condenser coil temperature sensor T3 is in open circuit or has short circuited	TS27
5 times	OFF	EC 54	Compressor discharge temperature sensor TP is in open circuit or has short circuited	TS27
5 times	OFF	EC 56	Evaporator coil outlet temperature sensor T2B is in open circuit or has short circuited(for free-match indoor units)	TS27
5 times	ON	EC 51	Outdoor unit EEPROM parameter error	TS20
12 times	OFF	EC 07	The outdoor fan speed is operating outside of the normal range(for some models)	TS23
7 times	FLASH	PC 00	IPM malfunction or IGBT over-strong current protection	TS30
2 times	FLASH	PC 01	Over voltage or over low voltage protection	TS31
3 times	FLASH	PC 02	Top temperature protection of compressor or High temperature protection of IPM module	TS34
5 times	FLASH	PC 04	Inverter compressor drive error	TS32
7 times	FLASH	PC 03	High pressure protection or low pressure protection (for some models)	TS43/ TS33
14 times	OFF	EC 0d	Outdoor unit malfunction	TS35
1 time	ON	--	Indoor units mode conflict(match with multi outdoor unit) (for some models)	--

For other errors:

The display board may show a garbled code or a code undefined by the service manual. Ensure that this code is not a temperature reading.

Troubleshooting:

Test the unit using the remote control. If the unit does not respond to the remote, the indoor PCB requires replacement. If the unit responds, the display board requires replacement.

LED flash frequency:

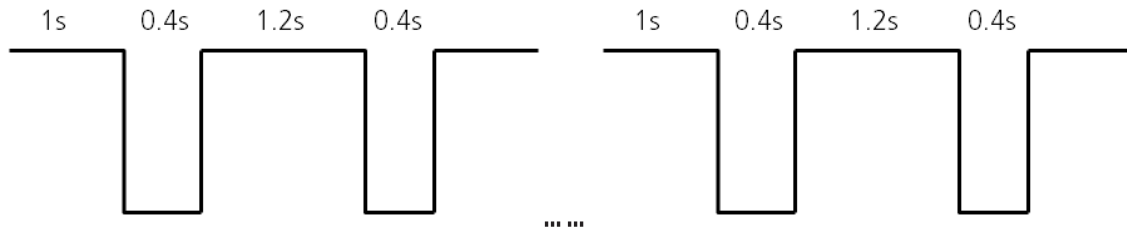

2.2 Error Display (For Some Outdoor Units)

Display	Malfunction or Protection	Solution
EE 51	Outdoor EEPROM malfunction	TS20
EL 01	Indoor / outdoor units communication error	TS21
PC 40	Communication malfunction between IPM board and outdoor main board	TS36
PC 08	Outdoor overcurrent protection	TS37
PC 10	Outdoor unit low AC voltage protection	TS31
PC 11	Outdoor unit main control board DC bus high voltage protection	TS31
PC 12	Outdoor unit main control board DC bus high voltage protection /341 MCE error	TS31
PC 00	IPM module protection	TS30
PC 0F	PFC module protection	TS39
EE 71	Over current failure of outdoor DC fan motor	TS23
EE 72	Lack phase failure of outdoor DC fan motor	TS40
EE 07	Outdoor fan speed has been out of control	TS23
PC 43	Outdoor compressor lack phase protection	TS41
PC 44	Outdoor unit zero speed protection	TS37
PC 45	Outdoor unit IR chip drive failure	TS42
PC 46	Compressor speed has been out of control	TS37
PC 49	Compressor overcurrent failure	TS37
PC 30	High pressure protection	TS43
PC 31	Low pressure protection	TS33
PC 0R	High temperature protection of condenser	TS45
PC 06	Temperature protection of compressor discharge	TS46
PC 02	Top temperature protection of compressor	TS34
EE 52	Condenser coil temperature sensor T3 is in open circuit or has short circuited	TS27
EE 53	Outdoor room temperature sensor T4 is in open circuit or has short circuited	TS27
EE 54	Compressor discharge temperature sensor TP is in open circuit or has short circuited	TS27
EE 50	Open or short circuit of outdoor unit temperature sensor(T3,T4,TP)	TS27
PC 0L	Low ambient temperature protection	TS42

3. Information Inquiry

Duct type &Floor ceiling Type:

- To enter information inquiry status, complete the following procedure within ten seconds:
 - Press LED(or DO NOT DISTURB) 3 times.
 - Press SWING(or AIR DIRECTION) 3 times.
- Finish 1 and 2 within 10 seconds, you will hear beeps for two seconds, which means the unit goes into parameter checking mode.
- Use the LED(or DO NOT DISTURB) and SWING(or AIR DIRECTION) buttons to cycle through information displayed.
- Pressing LED(or DO NOT DISTURB) will display the next code in the sequence. Pressing SWING(or AIR DIRECTION) will show the previous.
- The following table shows information codes. The screen will display this code for two seconds, then the information for 25 seconds.

Displayed code	Explanation	Displayed value	Meaning	Additional Notes
T1	Room temperature	-1F,-1E,-1d,-1c,-1b,-1A -19—99 A0,A1,...A9 b0,b1,...b9 c0,c1,...c9 d0,d1,...d9 E0,E1,...E9 F0,F1,...F9	-25,-24,-23,-22,-21,-20 -19—99 100,101,...109 110,111,...119 120,121,...129 130,131,...139 140,141,...149 150,151,...159	<ol style="list-style-type: none"> All displayed temperatures use actual values. All temperatures are displayed in °C regardless of remote used. T1, T2, T3, T4, and T2B display ranges from -25 to 70 °C. TP display ranges from -20 to 130 °C. The frequency display ranges from 0 to 159HZ. If the actual values exceed or fall short of the defined range, the values closest to the maximum and minimum values will be displayed.
T2	Indoor coil temperature			
T3	Outdoor coil temperature			
T4	Ambient temperature			
TB	Outlet temperature of indoor coil			
TP	Discharge temperature			
TH	Suction temperature			
FT	Targeted frequency			
FR	Actual frequency			
F	Indoor fan speed	0 1,2,3,4	OFF Low speed, Medium speed, High speed, Turbo.	N/A Used for some large capacity motors.
OF	Outdoor fan speed	14-FF	Actual fan speed is equal to the display value converted to decimal value and multiplied by 10. This is measured in RPM.	Used for some small capacity motors. The display value is 14-FF (hexadecimal). The corresponding fan speed ranges from 200 to 2550RPM.
LR	EXV opening angle	0-FF	Actual EXV opening value is equal to the display value converted to decimal value and then multiplied by 2.	-
CT	Compressor continuous running time	0-FF	0-255 minutes	If the actual value exceeds or falls short of the defined range, the value closest to the maximum and minimum will be displayed.
ST	Causes of compressor stop	0-99	For a detailed explanation, contact technical support.	-

Displayed code	Explanation	Displayed value	Meaning	Additional Notes	
R0	Reserved				
R1					
b0					
b1					
b2					
b3					
b4					
b5			0-FF		
b6			0-63	-	-
dL			0-FF		
Rc					
Uo					
Td					
NR					
CF					
PR					
Po					

Console Type& Compact Cassette Type:

- To enter information inquiry status, complete the following procedure within ten seconds:
 - Press LED(or DO NOT DISTURB) 3 times.
 - Press SWING(or AIR DIRECTION) 3 times.
- Finish 1 and 2 within 10 seconds, you will hear beeps for two seconds, which means the unit goes into parameter checking mode.
- Use the LED(or DO NOT DISTURB) and SWING(or AIR DIRECTION) buttons to cycle through information displayed.
- Pressing LED(or DO NOT DISTURB) will display the next code in the sequence. Pressing SWING(or AIR DIRECTION) will show the previous.
- The following table shows information codes. The screen will display this code for two seconds, then the information for 25 seconds.

Displayed code	Explanation	Additional Notes
Error code	Error code	Refer to next list of error code
T1	Room temperature	T1 temperature
T2	Indoor coil temperature	T2 temperature
T3	Outdoor coil temperature	T3 temperature
T4	Ambient temperature	T4 temperature
TP	Discharge temperature	TP temperature
FT	Targeted frequency	Targeted Frequency
Fr	Actual frequency	Actual Frequency
dL	Compressor current	N/A
Uo	Outdoor AC voltage	N/A
Sn	Indoor capacity test	N/A
od	Running mode	
Pr	Outdoor fan speed	Outdoor fan speed=value*8
Lr	EXV opening angle	EXV opening angle=value*8
ir	Indoor fan speed	Indoor fan speed=value*8
HU	Indoor humidity	N/A
TT	Adjusted setting temperature	N/A
DT	Reserve	N/A
fF	Reserve	N/A
nR	Reserve	N/A
oT	GA algorithm frequency	N/A

Super-slim Four-way Cassette Type:

- To enter engineer mode, in power-on or standby mode, and in non-locked state, press the key combination “ON/OFF + Air Speed” for 7s:
- After entering the engineer mode, the remote control will display icons of “Auto, Cool, Dry, Heat”, and the Battery icon; at the same time, it will also display the numeric code of the current engineer mode (for the initial engineer mode, the numeric code displayed is 0), and all other icons are inactive.
- In engineer mode, the value of the current numeric code can be adjusted circularly through the Up/Down key, with the setting range of 0 to 30.

Code	Query Content	Additional Notes
0	Error code	Refer to next list of error code
1	Room temperature	T1 temperature
2	Indoor coil temperature	T2 temperature
3	Outdoor coil temperature	T3 temperature
4	Ambient temperature	T4 temperature
5	Discharge temperature	TP temperature
6	Compressor Target Frequency FT	Targeted Frequency
7	Compressor Running Frequency Fr	Actual Frequency
8	Unit Current dL	N/A
9	Outdoor AC Voltage Uo	N/A
10	Current indoor capacity test state Sn	N/A
11	Runnig mode od	
12	Set Speed Pr of the outdoor fan	Outdoor fan speed=value*8
13	Opening Lr of EEV	EXV opening angle-value*8
14	Actual Running Speed ir of the indoor fan	Indoor fan speed=value*8
15	Indoor Humidity Hu	N/A
16	Set Temperature TT after compensation	N/A
17		N/A
18		N/A
19	/	N/A
20	Indoor Target Frequency oT	N/A
21	Reserve	
22		
23		
24		
25		
26		
27		
28		
29		
30		

Exit of engineer mode:

1)In engineer mode, press the key combination of “On/Off + Air speed” for 2s;

2)The engineer mode will be exited if there are no valid key operations for continuous 60s.

Error code of engineer mode

Display	Error Information
E400/E40A	Indoor unit EEPROM parameter error
E401	Indoor / outdoor unit communication error
E40A	Communication error between indoor unit and indoor external fan module
E430	Parameters error of indoor external fan
E435	Phase failure of indoor external fan
E436	Indoor external fan current sampling bias fault
E437	Indoor external fan zero speed failure
E438	Indoor external fan stall failure
E439	Out of step failure of indoor external fan
E43A	Low voltage protection of indoor external fan DC bus
E43B	Indoor external fan DC bus voltage is too high fault
E43E	Indoor external fan overcurrent fault
E43F	Indoor external fan module protection/hardware overcurrent protection
E403	The indoor fan speed is operating outside of the normal range
E451	Outdoor unit EEPROM parameter error
E452	Condenser coil temperature sensor T3 is in open circuit or has short circuited
E453	Outdoor room temperature sensor T4 is in open circuit or has short circuited
E454	Compressor discharge temperature sensor TP is in open circuit or has short circuited
E455	IGBT temperature sensor TH is in open circuit or has short circuited
E40d	Outdoor unit malfunction
E460	Indoor room temperature sensor T1 is in open circuit or has short circuited
E461	Evaporator coil temperature sensor T2 is in open circuit or has short circuited
E471	Outdoor external fan overcurrent fault
E475	Outdoor external fan module protection/hardware overcurrent protection
E472	Outdoor external fan phase failure
E474	Outdoor external fan current sampling bias fault
E473	Zero speed failure of outdoor unit DC fan
E407	The outdoor fan speed is operating outside of the normal range(
E40C	Refrigerant leak detected
E40E	Water-level alarm malfunction
PC00	IPM malfunction or IGBT over-strong current protection
PC10	Over low voltage protection
PC11	Over voltage protection
PC12	DC voltage protection
PC02	Top temperature protection of compressor or High temperature protection of IPM module

PC 40	Communication error between outdoor main chip and compressor driven chip
PC 41	Current Input detection protection
PC 42	Compressor start error
PC 43	Lack of phase (3 phase) protection
PC 44	Outdoor unit zero speed protection
PC 45	341PWM error
PC 46	Compressor speed malfunction
PC 49	Compressor over current protection
PC 06	Compressor discharge temperature protection
PC 08	Outdoor current protection
PH 09	Anti-cold air in heating mode
PC 0F	PFC module malfunction
PC 30	System overpressure protection
PC 31	System pressure is too low protection
PC 03	Pressure protection
PC 0L	Outdoor low ambient temperature protection
PH 90	Evaporator coil temperature over high protection
PH 91	Evaporator coil temperature over low Protection
PC 0R	Condenser high temperature protection
PH 0C	Indoor unit humidity sensor failure
LH 00	Frequency limit caused by T2
LH 30	Indoor external fan current limit
LH 31	Indoor external fan voltage limit
LC 01	Frequency limit caused by T3
LC 02	Frequency limit caused by TP
LC 05	Frequency limit caused by voltage
LC 03	Frequency limit caused by current
LC 06	Frequency limit caused by PFC
LC 30	Frequency limit caused by high pressure
LC 31	Frequency limit caused by low pressure
LH 07	Frequency limit caused by remote controller
--	Indoor units mode conflict(match with multi outdoor unit)

4. Error Diagnosis and Troubleshooting Without Error Code

WARNING

Be sure to turn off unit before any maintenance to prevent damage or injury.

4.1 Remote maintenance

SUGGESTION: When troubles occur, please check the following points with customers before field maintenance.

No.	Problem	Solution
1	Unit will not start	TS15 - TS16
2	The power switch is on but fans will not start	TS15 - TS16
3	The temperature on the display board cannot be set	TS15 - TS16
4	Unit is on but the wind is not cold(hot)	TS15 - TS16
5	Unit runs, but shortly stops	TS15 - TS16
6	The unit starts up and stops frequently	TS15 - TS16
7	Unit runs continuously but insufficient cooling(heating)	TS15 - TS16
8	Cool can not change to heat	TS15 - TS16
9	Unit is noisy	TS15 - TS16

4.2 Field maintenance

	Problem	Solution
1	Unit will not start	TS17 - TS18
2	Compressor will not start but fans run	TS17 - TS18
3	Compressor and condenser (outdoor) fan will not start	TS17 - TS18
4	Evaporator (indoor) fan will not start	TS17 - TS18
5	Condenser (Outdoor) fan will not start	TS17 - TS18
6	Unit runs, but shortly stops	TS17 - TS18
7	Compressor short-cycles due to overload	TS17 - TS18
8	High discharge pressure	TS17 - TS18
9	Low discharge pressure	TS17 - TS18
10	High suction pressure	TS17 - TS18
11	Low suction pressure	TS17 - TS18
12	Unit runs continuously but insufficient cooling	TS17 - TS18
13	Too cool	TS17 - TS18
14	Compressor is noisy	TS17 - TS18
15	Horizontal louver can not revolve	TS17 - TS18

1.Remote Maintenance	Electrical Circuit				Refrigerant Circuit									
Possible causes of trouble	Power failure	The main power tripped	Loose connections	Faulty transformer	The voltage is too high or too low	The remote control is powered off	Broken remote control	Dirty air filter	Dirty condenser fins	The setting temperature is higher/lower than the room's(cooling/heating)	The ambient temperature is too high/low when the mode is cooling/heating	Fan mode	SILENCE function is activated(optional function)	Frosting and defrosting frequently
	Unit will not start	☆	☆	☆	☆									
	The power switch is on but fans will not start			☆	☆	☆								
	The temperature on the display board cannot be set						☆	☆						
	Unit is on but the wind is not cold(hot)									☆	☆	☆		
	Unit runs, but shortly stops					☆				☆	☆			
	The unit starts up and stops frequently					☆					☆			☆
	Unit runs continuously but insufficient cooling(heating)								☆	☆	☆	☆	☆	
	Cool can not change to heat													
	Unit is noisy													
Test method / remedy	Test voltage													
	Close the power switch													
	Inspect connections - tighten													
	Change the transformer													
	Test voltage													
	Replace the battery of the remote control													
	Replace the remote control													
	Clean or replace								☆	☆				
	Clean													
	Adjust the setting temperature													
Turn the AC later														
Adjust to cool mode														
Turn off SILENCE function.														
Turn the AC later														

1.Remote Maintenance	Others					
Possible causes of trouble	Heavy load condition	Loosen hold down bolts and / or screws	Bad airproof	The air inlet or outlet of either unit is blocked	Interference from cell phone towers and remote boosters	Shipping plates remain attached
	Unit will not start					
	The power switch is on but fans will not start				☆	
	The temperature on the display board cannot be set					
	Unit is on but the wind is not cold(hot)					
	Unit runs, but shortly stops					
The unit starts up and stops frequently				☆		
Unit runs continuously but insufficient cooling(heating)	☆		☆	☆		
Cool can not change to heat						
Unit is noisy		☆			☆	
Test method / remedy	Check heat load	Tighten bolts or screws	Close all the windows and doors	Remove the obstacles	Reconnect the power or press ON/OFF button on remote control to restart operation	Remove them

2.Field Maintenance	Refrigerant Circuit													Others										
Possible causes of trouble	Compressor stuck	Shortage of refrigerant	Restricted liquid line	Dirty air filter	Dirty evaporator coil	Insufficient air through evaporator coil	Overcharge of refrigerant	Dirty or partially blocked condenser	Air or incompressible gas in refrigerant cycle	Short cycling of condensing air	High temperature condensing medium	Insufficient condensing medium	Broken compressor internal parts	Inefficient compressor	Expansion valve obstructed	Expansion valve or capillary tube closed completely	Leaking power element on expansion valve	Poor installation of feeler bulb	Heavy load condition	Loosen hold down bolts and / or screws	Shipping plates remain attached	Poor choices of capacity	Contact of piping with other piping or external plate	
Unit will not start																								
Compressor will not start but fans run	☆																							
Compressor and condenser (outdoor) fan will not start																								
Evaporator (indoor) fan will not start																								
Condenser (Outdoor) fan will not start																								
Unit runs, but shortly stops		☆	☆				☆	☆								☆	☆							
Compressor short-cycles due to overload		☆					☆	☆																
High discharge pressure							☆	☆	☆	☆	☆													
Low discharge pressure		☆													☆									
High suction pressure							☆							☆				☆	☆					
Low suction pressure		☆	☆	☆	☆	☆									☆	☆	☆							
Unit runs continuously but insufficient cooling		☆	☆	☆	☆	☆		☆	☆	☆				☆					☆			☆		
Too cool																								
Compressor is noisy							☆						☆							☆	☆		☆	
Horizontal louver can not revolve																								
Test method / remedy	Replace the compressor	Leak test	Replace restricted part	Clean or replace	Clean coil	Check fan	Change charged refrigerant volume	Clean condenser or remove obstacle	Purge, evacuate and recharge	Remove obstruction to air flow	Remove obstruction in air or water flow	Remove obstruction in air or water flow	Replace compressor	Test compressor efficiency	Replace valve	Replace valve	Replace valve	Fix feeler bulb	Check heat load	Tighten bolts or screws	Remove them	Choose AC of larger capacity or add the number of AC	Rectify piping so as not to contact each other or with external plate	

2.Field Maintenance	Electrical Circuit														
Possible causes of trouble	Power failure	Blown fuse or varistor	Loose connections	Shorted or broken wires	Safety device opens	Faulty thermostat / room temperature sensor	Wrong setting place of temperature sensor	Faulty transformer	Shorted or open capacitor	Faulty magnetic contactor for compressor	Faulty magnetic contactor for fan	Low voltage	Faulty stepping motor	Shorted or grounded compressor	Shorted or grounded fan motor
Unit will not start	☆	☆	☆	☆	☆			☆							
Compressor will not start but fans run				☆	☆				☆	☆				☆	
Compressor and condenser (outdoor) fan will not start				☆	☆					☆					
Evaporator (indoor) fan will not start				☆					☆		☆				☆
Condenser (Outdoor) fan will not start				☆	☆				☆		☆				☆
Unit runs, but shortly stops										☆		☆			
Compressor short-cycles due to overload										☆		☆			
High discharge pressure															
Low discharge pressure															
High suction pressure															
Low suction pressure															
Unit runs continuously but insufficient cooling															
Too cool						☆	☆								
Compressor is noisy															
Horizontal louver can not revolve			☆	☆									☆		
Test method / remedy	Test voltage	Inspect fuse type & size	Inspect connections - tighten	Test circuits with tester	Test continuity of safety device	Test continuity of thermostat / sensor & wiring Place the temperature sensor at the central of the air inlet grille.		Check control circuit with tester	Check capacitor with tester	Test continuity of coil & contacts	Test continuity of coil & contacts	Test voltage	Replace the stepping motor	Check resistance with multimeter	Check resistance with multimeter

5. Quick Maintenance by Error Code

If you do not have the time to test which specific parts are faulty, you can directly change the required parts according to the error code.

You can find the parts to replace by error code in the following table.

Part requiring replacement	Error Code							
	EH00/EH0R	EL01	EH03	EH60	EH61	EL0C	EH0E	EC53
Indoor PCB	✓	✓	✓	✓	✓	✓	✓	x
Outdoor PCB	x	✓	x	x	x	x	x	✓
Indoor fan motor	x	x	✓	x	x	x	x	x
T1 sensor	x	x	x	✓	x	x	x	x
T2 Sensor	x	x	x	x	✓	✓	✓	x
T3 Sensor	x	x	x	x	x	x	x	x
T4 Sensor	x	x	x	x	x	x	x	✓
Reactor	x	✓	x	x	x	x	x	x
Compressor	x	x	x	x	x	x	x	x
Additional refrigerant	x	x	x	x	x	✓	✓	x
Water-level switch	x	x	x	x	x	x	✓	x
Water pump	x	x	x	x	x	x	✓	x

Part requiring replacement	EC54	EC51	EC52	EC07	PC00	PC01	PC02	PC04	PC03
Indoor PCB	x	x	x	x	x	x	x	x	x
Outdoor PCB	✓	✓	✓	✓	✓	✓	✓	✓	✓
Outdoor fan motor	x	x	x	✓	✓	x	✓	✓	x
T3 Sensor	x	x	✓	x	x	x	x	x	x
TP Sensor	✓	x	x	x	x	x	x	x	x
Reactor	x	x	x	x	x	✓	x	x	x
Compressor	x	x	x	x	✓	x	x	✓	x
IPM module board	x	x	x	x	✓	✓	✓	✓	x
Low pressure protector	x	x	x	x	x	x	x	x	✓
Additional refrigerant	x	x	x	x	x	x	x	x	✓

Note: For certain models, outdoor PCB could not be removed separately. In this case, the outdoor electric control box should be replaced as a whole.

6. Troubleshooting by Error Code

6.1 EH 00/ EH 0A / EC 51 (EEPROM Parameter Error Diagnosis and Solution)

Description: Indoor or outdoor PCB main chip does not receive feedback from EEPROM chip.

Recommended parts to prepare:

- Indoor PCB
- Outdoor PCB

Troubleshooting and repair:

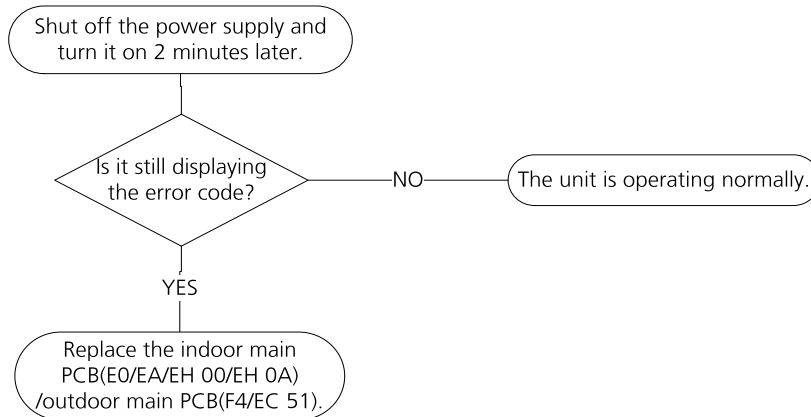

Remarks:

EEPROM: A read-only memory whose contents can be erased and reprogrammed using a pulsed voltage.

The location of the EEPROM chip on the indoor and outdoor PCB is shown in the following two images:

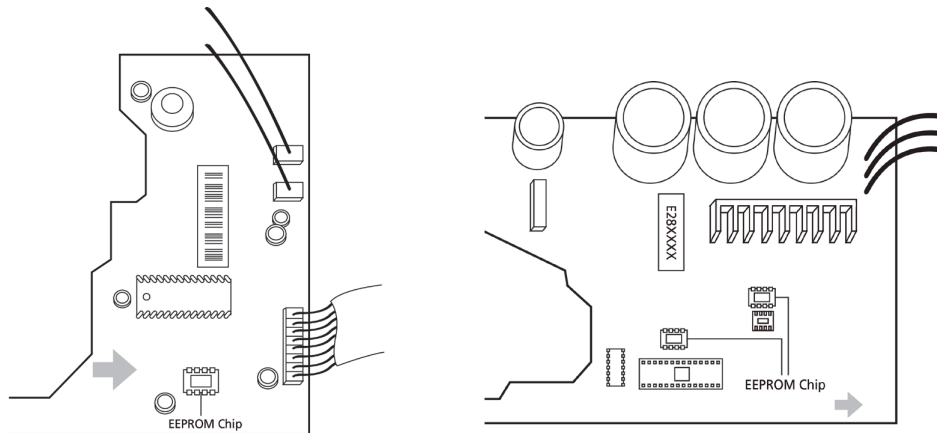

Note: For certain models, outdoor PCB could not be removed separately. In this case, the outdoor electric control box should be replaced as a whole. This pictures are only for reference, actual appearance may vary.

Troubleshooting and repair of compressor driven chip EEPROM parameter error and communication error between outdoor main chip and compressor driven chip are same as EC 51.

6.2 EL 01 (Indoor and Outdoor Unit Communication Error Diagnosis and Solution)

Description: Indoor unit can not communicate with outdoor unit

Recommended parts to prepare:

- Indoor PCB
- Outdoor PCB
- Reactor

Troubleshooting and repair:

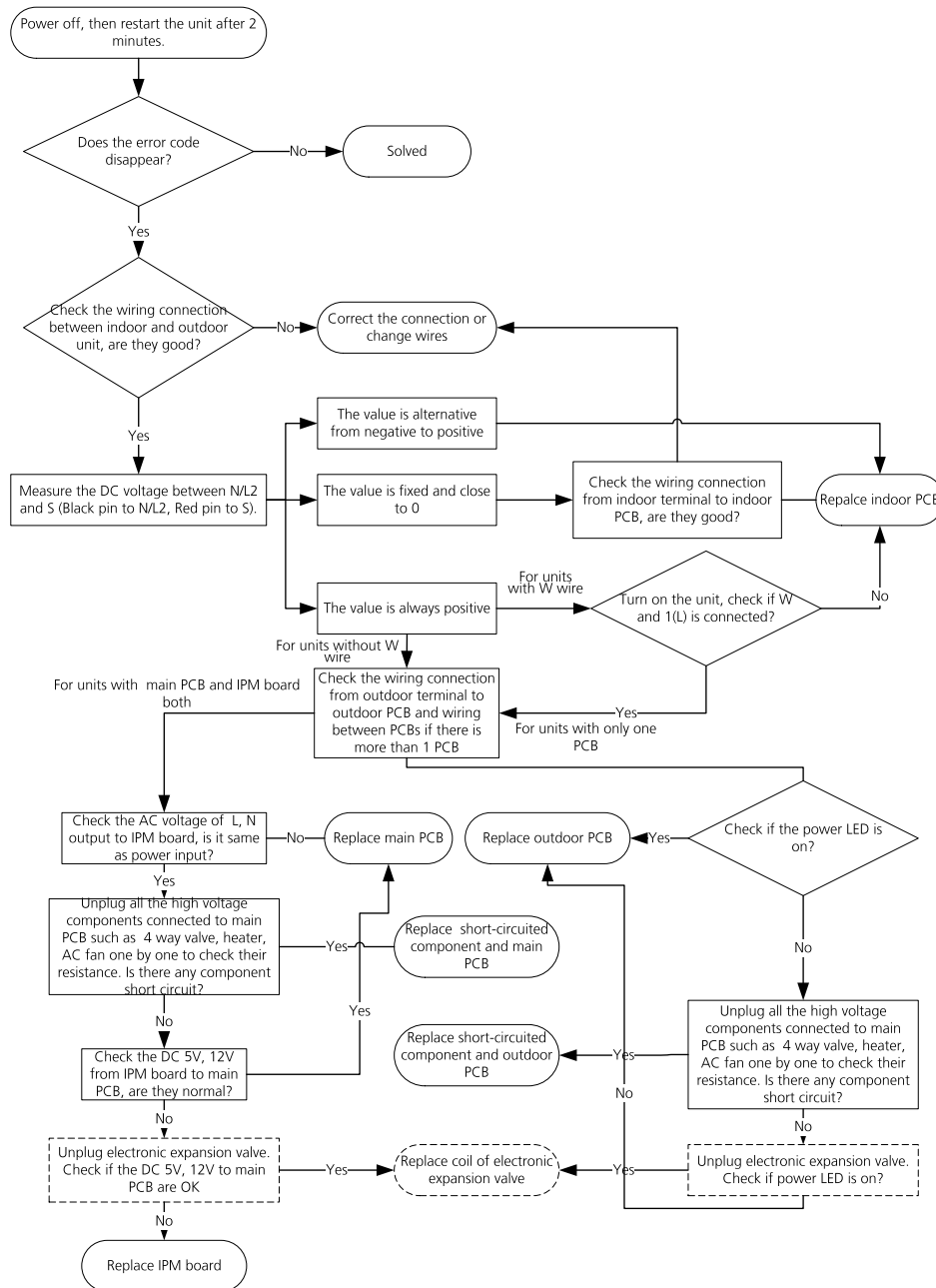

Note: For certain models, outdoor PCB could not be removed separately. In this case, the outdoor electric

control box should be replaced as a whole.

Remarks:

- Use a multimeter to test the DC voltage between 2 port(or S or L2 port) and 3 port(or N or S port) of outdoor unit.
The red pin of multimeter connects with 2 port(or S or L2 port) while the black pin is for 3 port(or N or S port) .
- When AC is operating normally, the voltage is moving alternately as positive values and negative values
- If the outdoor unit has malfunction, the voltage has always been the positive value.
- While if the indoor unit has malfunction, the voltage has always been a certain value.

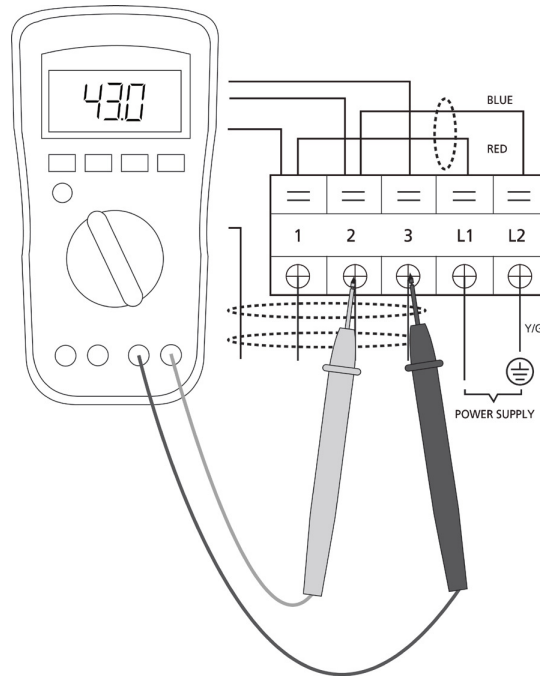

- Use a multimeter to test the resistance of the reactor which does not connect with capacitor.
- The normal value should be around zero ohm. Otherwise, the reactor must have malfunction.

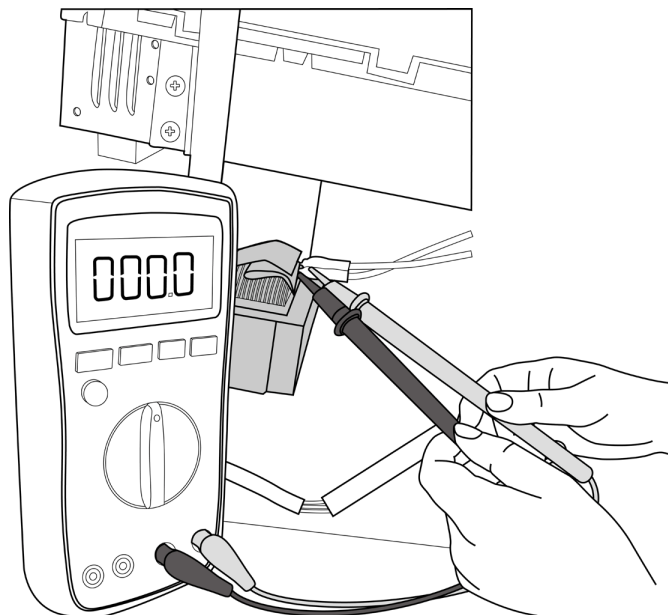

Note: The picture and the value are only for reference, actual condition and specific value may vary.

6.3 EH 03 / EC 07 (Fan Speed Is Operating Outside of Normal Range)/EC 71(Over Current Failure of Outdoor DC Fan Motor) Diagnosis and Solution

Description: When indoor / outdoor fan speed keeps too low or too high for a certain time, the unit ceases operation and the LED displays the failure.

Recommended parts to prepare:

- Connection wires
- Fan assembly
- Fan motor
- PCB

Troubleshooting and repair:

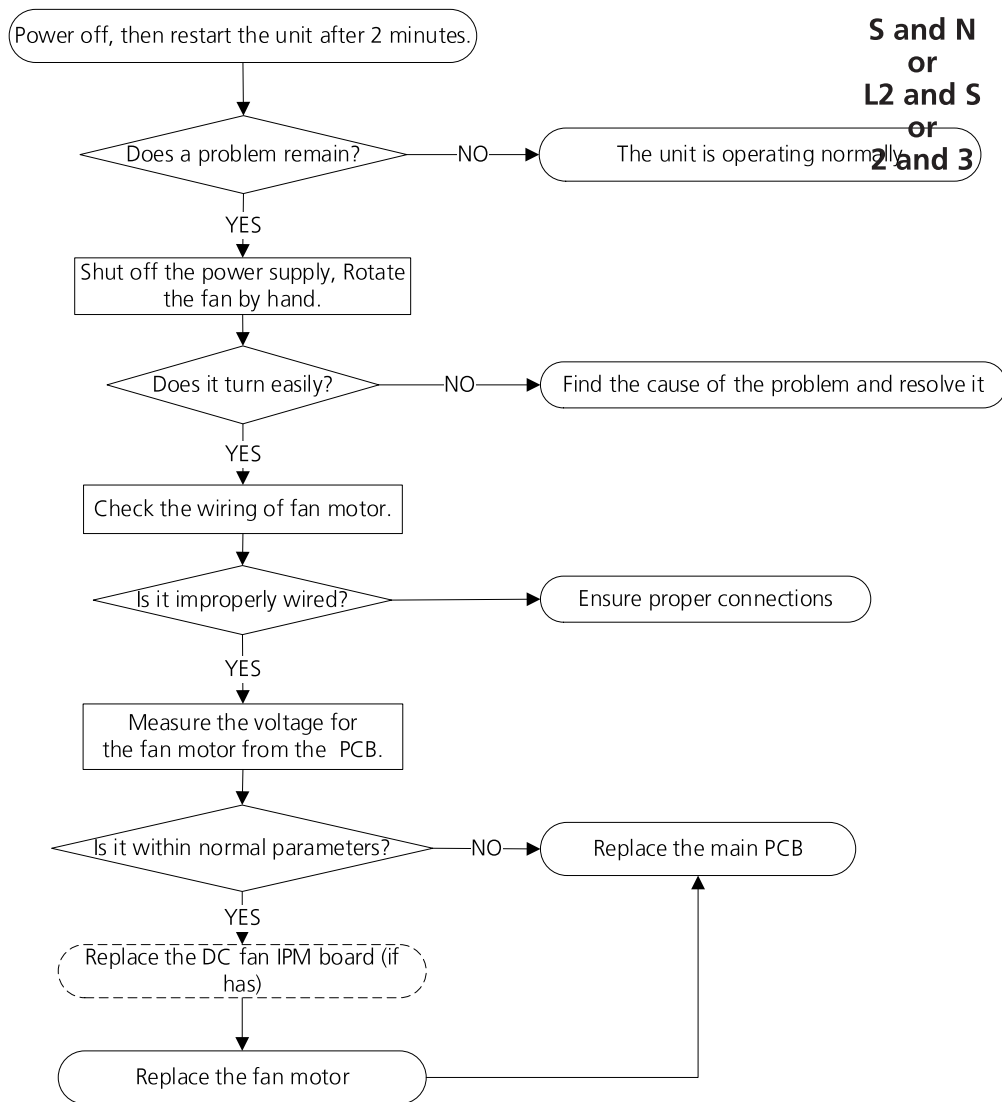

Note: For certain models, outdoor PCB could not be removed separately. In this case, the outdoor electric control box should be replaced as a whole.

Index:

1. Indoor or Outdoor DC Fan Motor(control chip is in fan motor)

Power on and when the unit is in standby, measure the voltage of pin1-pin3, pin4-pin3 in fan motor connector. If the value of the voltage is not in the range showing in below table, the PCB must has problems and need to be replaced.

No.	Color	Signal	Voltage
1	Red	Vs/Vm	192V~380V
2	---	---	---
3	Black	GND	0V
4	White	Vcc	13.5-16.5V
5	Yellow	Vsp	0~6.5V
6	Blue	FG	13.5-16.5V

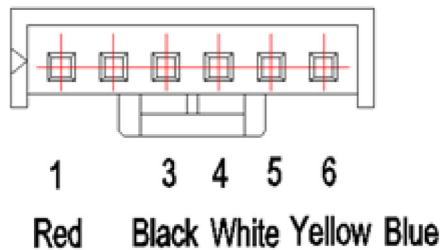

2. Indoor DC Fan IPM Board (Duct and Ceiling-floor Unit)

Power on and when the unit is in standby, measure the voltage of CON1, pin1-pin2 and pin3-pin2 of CN1 in DC motor driver board. If the value of the voltage is not in the range showing in below tables, the indoor main PCB must has problems and need to be replaced.

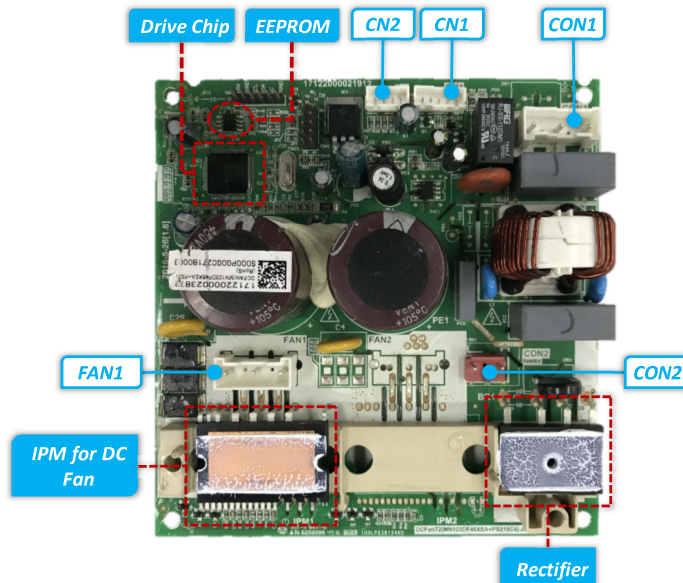

Port	Description	Parameter	Remark
CON1	Power input for the PCB	230V/AC	
CN1	Communication with main PCB	DC	
CN2	Test port	5V/DC	For debugging board
CN23	UVW output for DC fan motor		
CON2	Ports for reactor		

CN1 Communication with main PCB

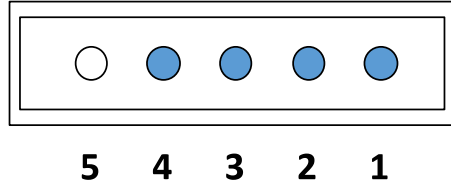

NO.	Signal	Voltage
1	Vcc	+15V
2	GND	
3	TXD	0~6V
4	RXD	0~15V
5	--	--

3. Outdoor DC Fan Motor (control chip is in outdoor PCB)

Release the UVW connector. Measure the resistance of U-V, U-W, V-W. If the resistance is not equal to each other, the fan motor must have problems and need to be replaced. Otherwise the PCB must have problems and need to be replaced.

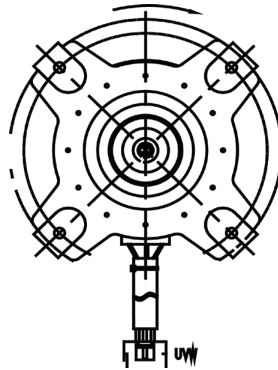

4. Outdoor DC Fan IPM Board (for some double fan models)

Power on and when the unit is in standby, measure the voltage of CON1, pin1-pin2 and pin3-pin2 of CN1 in DC motor driver board. If the value of the voltage is not in the range showing in below tables, the outdoor main PCB must have problems and need to be replaced.

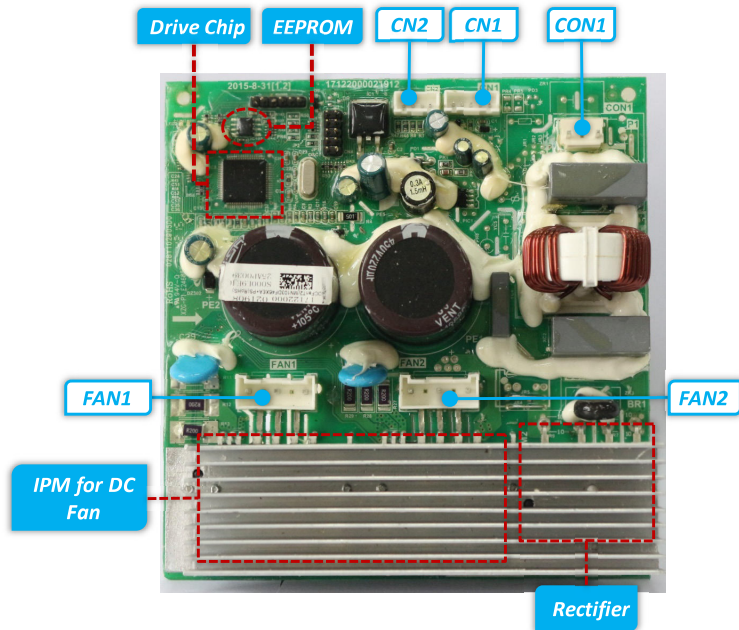

Part	Description	Parameter	Remark
CON1	Power input for the PCB	192-380V/DC	
CN1	Communication with main PCB	DC	
CN2	Test port	5V/DC	For debugging board
FAN1	UVW output for DC fan motor		
FAN2	UVW output for DC fan motor		

CN1 Communication with main PCB

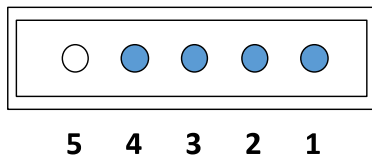

No.	Signal	Voltage
1	Vcc	13.5-16.5V
2	GND	0V
3	Vsp	0~6.5V
4	FG	13.5-16.5V
5	---	---

6.4 EH 60/EH 61/EC 53/EC 52/EC 54/EC 56/EC 50 (Open Circuit or Short Circuit of Temperature Sensor Diagnosis and Solution)

Description: If the sampling voltage is lower than 0.06V or higher than 4.94V, the LED displays the failure.

Recommended parts to prepare:

- Connection wires
- Sensors
- PCB

Troubleshooting and repair:

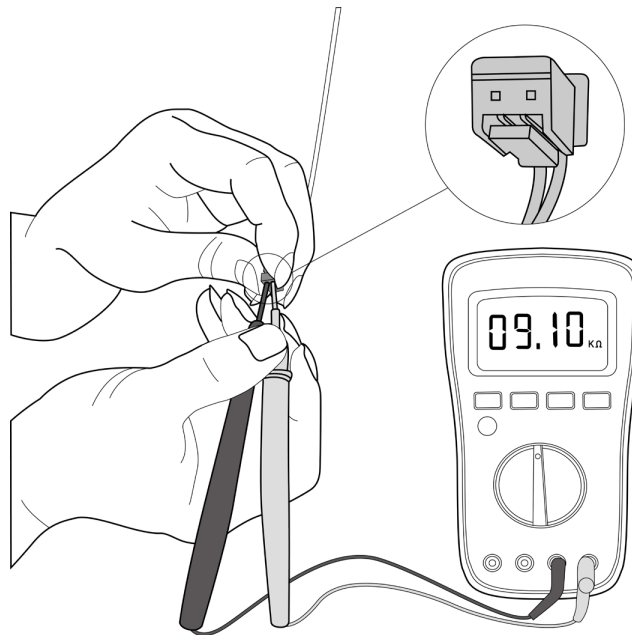
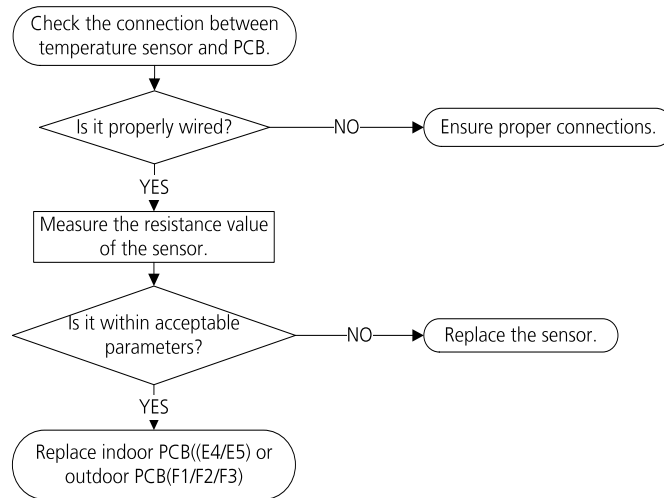

Note: For certain models, outdoor PCB could not be removed separately. In this case, the outdoor electric control box should be replaced as a whole. This picture and the value are only for reference, actual appearance and value may vary

6.5 EL 0C (Refrigerant Leakage Detection Diagnosis and Solution)

Description: Define the evaporator coil temperature T2 of the compressor just starts running as Tcool.

In the beginning 5 minutes after the compressor starts up, if $T2 < T_{cool} - 1^{\circ}\text{C}(1.8^{\circ}\text{F})$ does not keep continuous 4 seconds and compressor running frequency higher than 50Hz does not keep for 3 minutes, and this situation happens 3 times, the display area will show "EL 0C" and AC will turn off.

Recommended parts to prepare:

- T2 sensor
- Indoor PCB
- Additional refrigerant

Troubleshooting and repair:

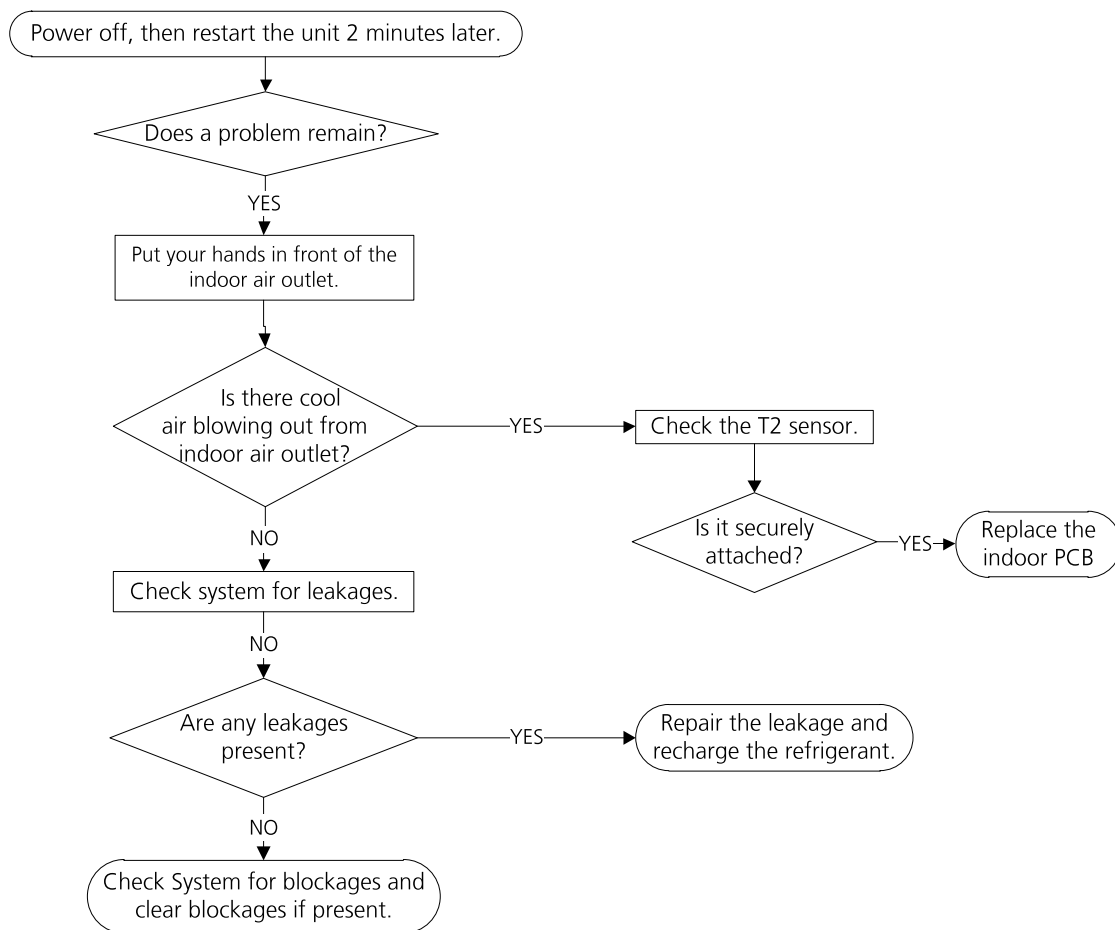

6.6 EH 0E(Water-Level Alarm Malfunction Diagnosis and Solution)

Description: If the sampling voltage is not 5V, the LED displays the failure code.

Recommended parts to prepare:

- Connection wires
- Water-level switch
- Water pump
- Indoor PCB

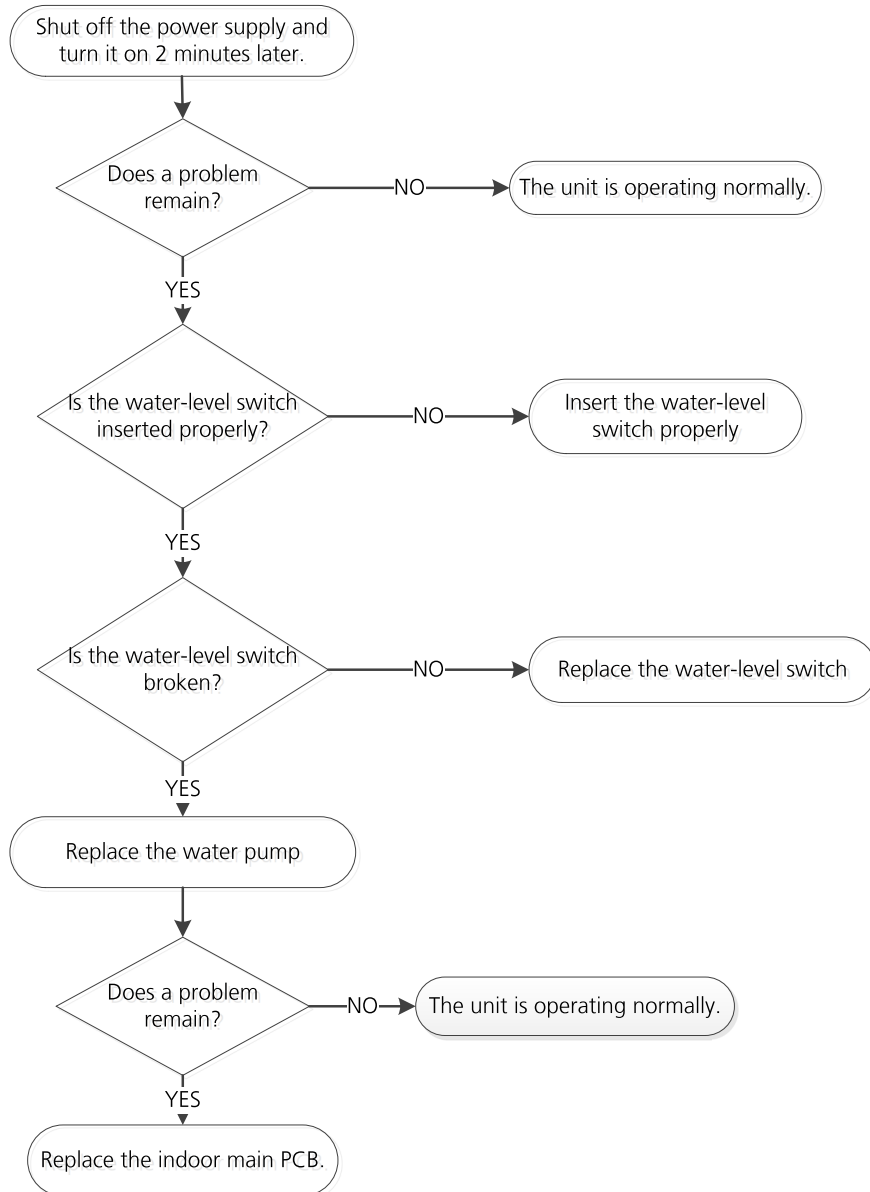

6.7 PC 00(IPM malfunction or IGBT over-strong current protection Diagnosis and Solution)

Description: When the voltage signal the IPM sends to the compressor drive chip is abnormal, the display LED shows “PC 00” and the AC turn off.

Recommended parts to prepare:

- Connection wires
- IPM module board
- Outdoor fan assembly
- Compressor
- Outdoor PCB

Troubleshooting and repair:

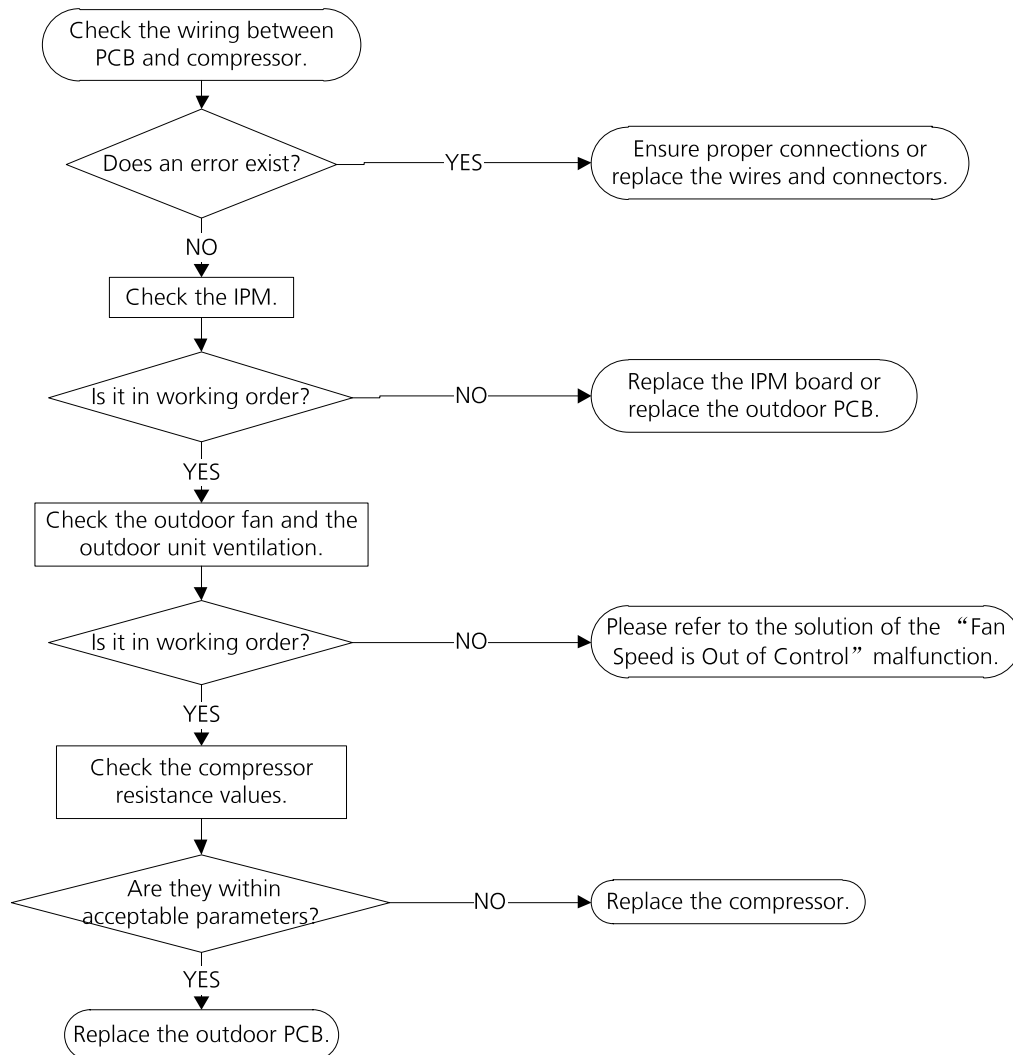

Note: For certain models, outdoor PCB could not be removed separately. In this case, the outdoor electric control box should be replaced as a whole.

6.8 PC 01(Over voltage or too low voltage protection)/PC 10(Outdoor unit low AC voltage protection)/PC 11(Outdoor unit main control board DC bus high voltage protection)/PC 12(Outdoor unit main control board DC bus high voltage protection /341 MCE error) Diagnosis and Solution

Description: Abnormal increases or decreases in voltage are detected by checking the specified voltage detection circuit.

Recommended parts to prepare:

- Power supply wires
- IPM module board
- PCB
- Reactor

Troubleshooting and repair:

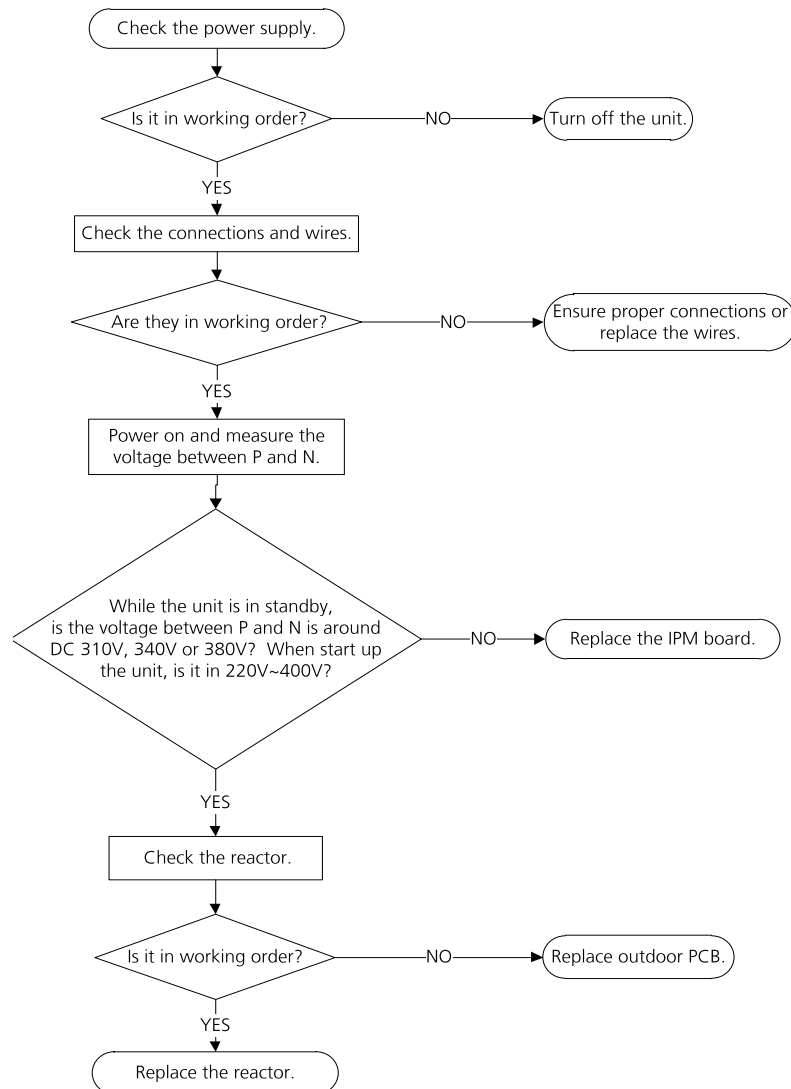

Note: For certain models, outdoor PCB could not be removed separately. In this case, the outdoor electric control box should be replaced as a whole.

6.9 PC 04(Inverter compressor drive error Diagnosis and Solution)

Description: An abnormal inverter compressor drive is detected by a special detection circuit, including communication signal detection, voltage detection, compressor rotation speed signal detection and so on.

Recommended parts to prepare:

- Connection wires
- IPM module board
- Outdoor fan assembly
- Compressor
- Outdoor PCB

Troubleshooting and repair:

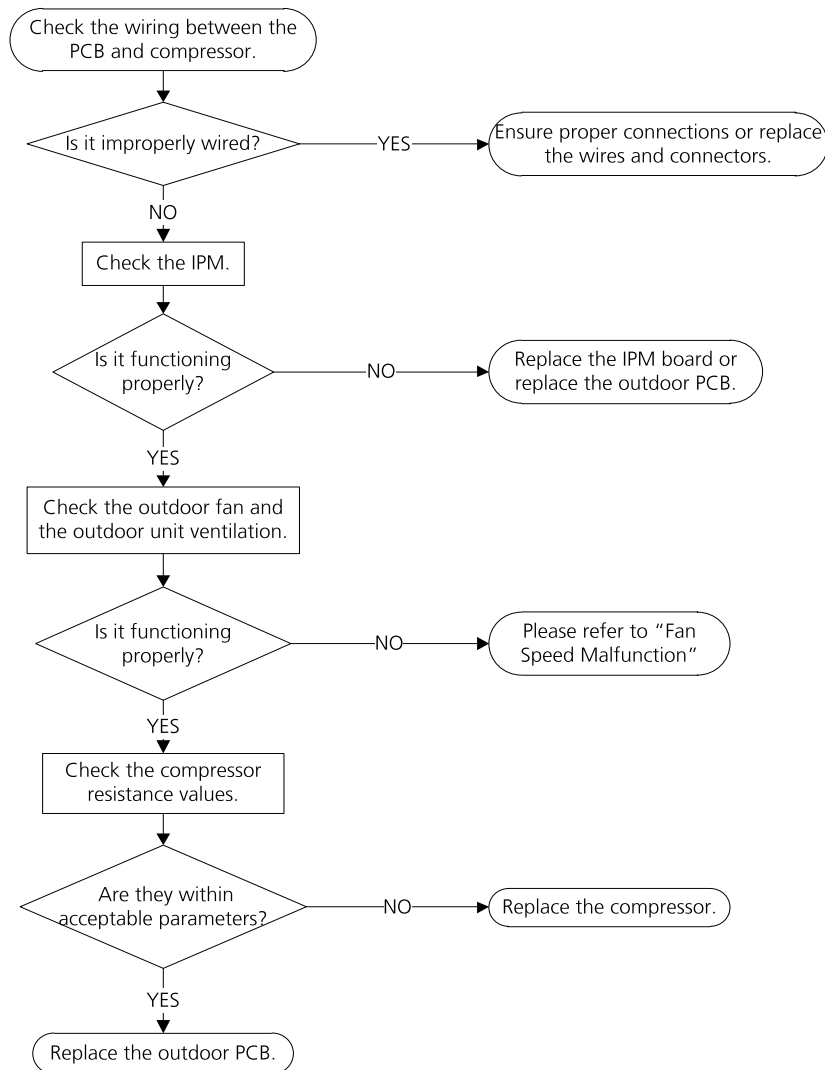

Note: For certain models, outdoor PCB could not be removed separately. In this case, the outdoor electric control box should be replaced as a whole.

Description: If the sampling voltage is not 5V, the LED displays a failure code.

Recommended parts to prepare:

- Connection wires
- Low pressure protector
- Indoor fan assembly
- Outdoor PCB

Troubleshooting and repair:

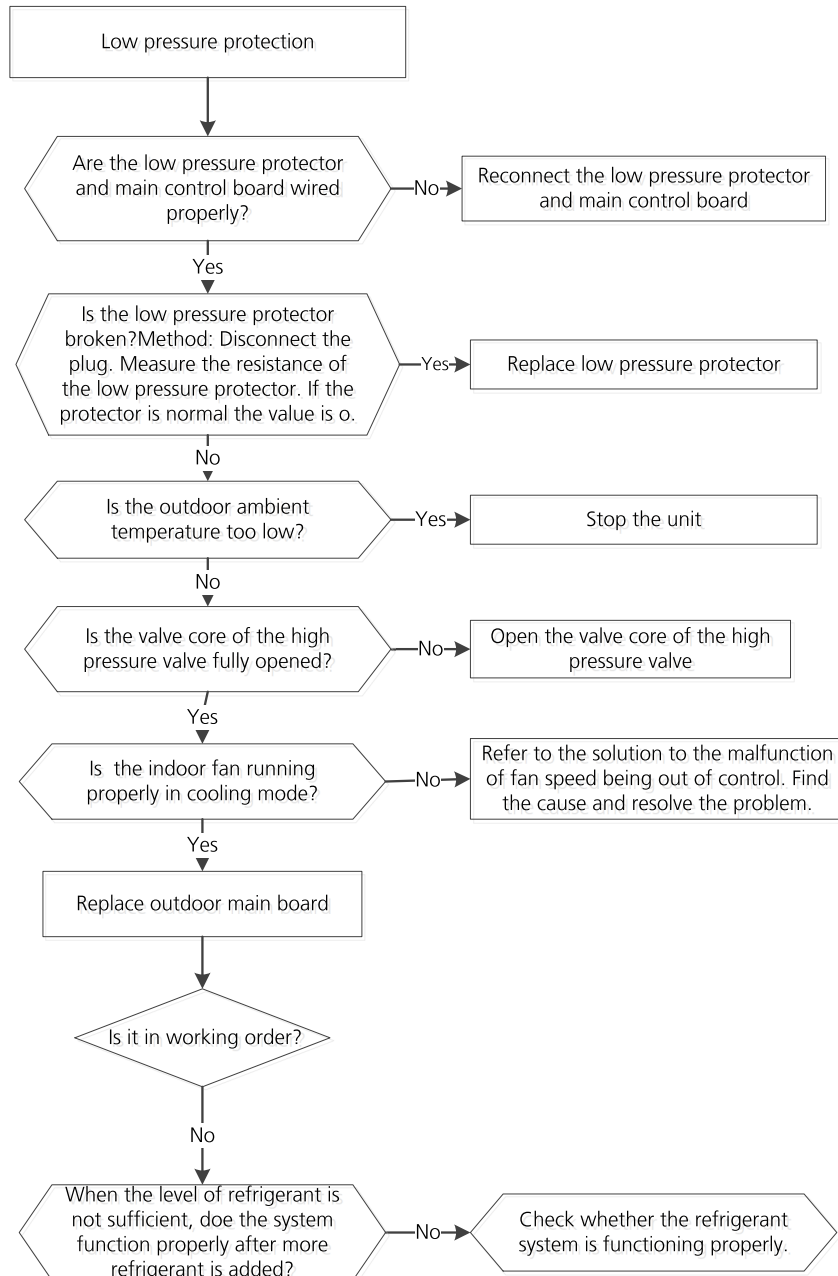

Note: For certain models, outdoor PCB could not be removed separately. In this case, the outdoor electric control box should be replaced as a whole.

6.11 PC 02(Top temperature protection of compressor or High temperature protection of IPM module diagnosis and solution)

Description: For some models with overload protection, If the sampling voltage is not 5V, the LED will display the failure. If the temperature of IPM module is higher than a certain value, the LED displays the failure code.

Recommended parts to prepare:

- Connection wires
- Outdoor PCB
- IPM module board
- High pressure protector
- System blockages

Troubleshooting and repair:

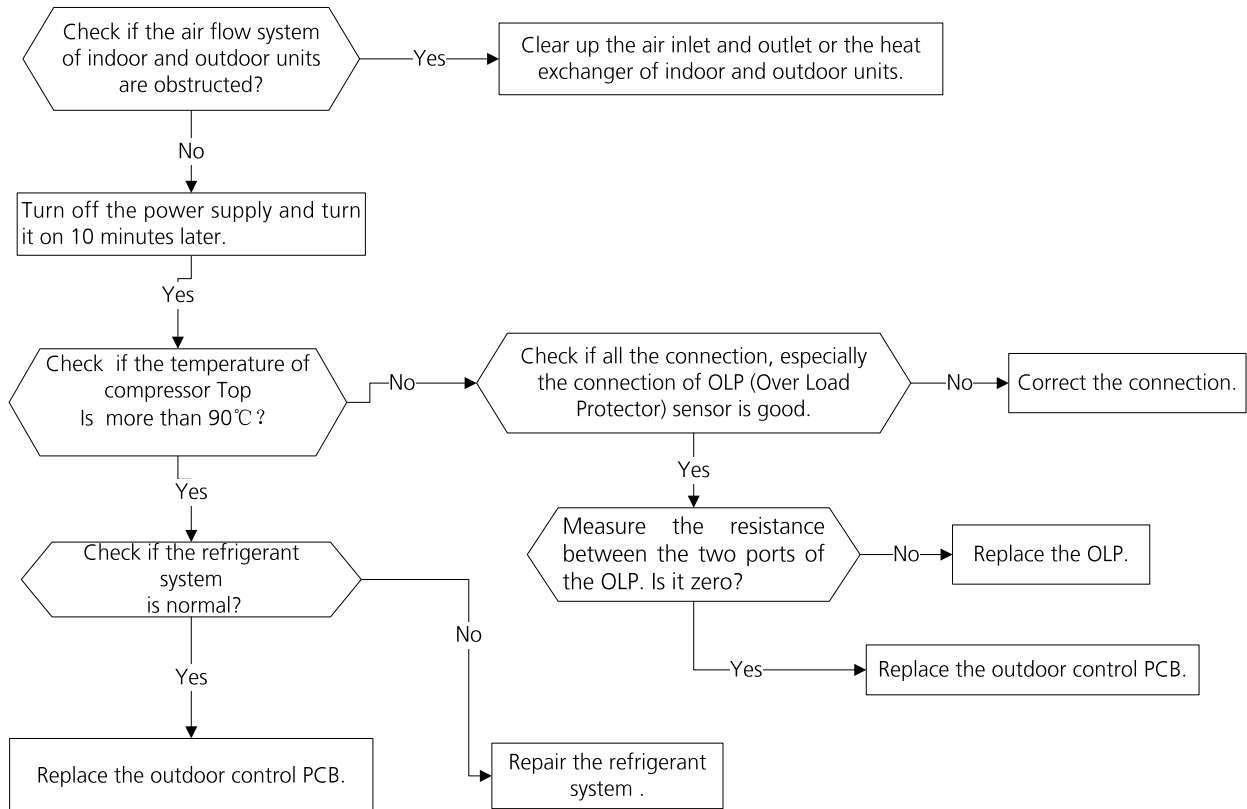

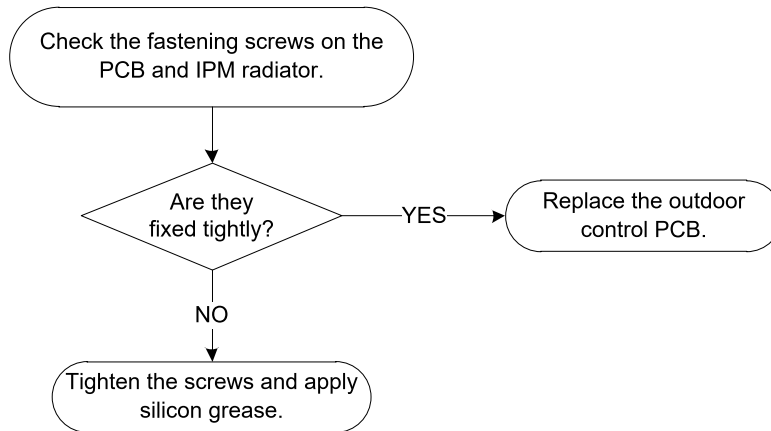

6.12 EC 0d(Outdoor unit malfunction Diagnosis and Solution)

Description: The indoor unit detect the outdoor unit is error.

Recommended parts to prepare:

- Outdoor unit

Troubleshooting and repair:

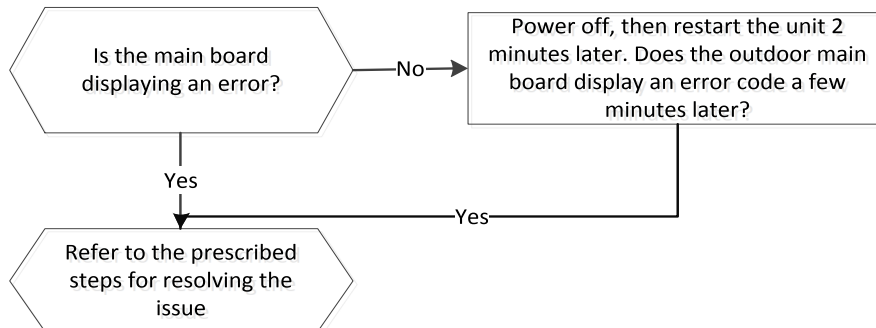

6.13 PC 40(Communication error between outdoor main PCB and IPM board diagnosis and solution)

Description: The main PCB cannot detect the IPM board.

Recommended parts to prepare:

- Connection wires
- IPM board
- Outdoor main PCB
- Electric control box

Troubleshooting and repair:

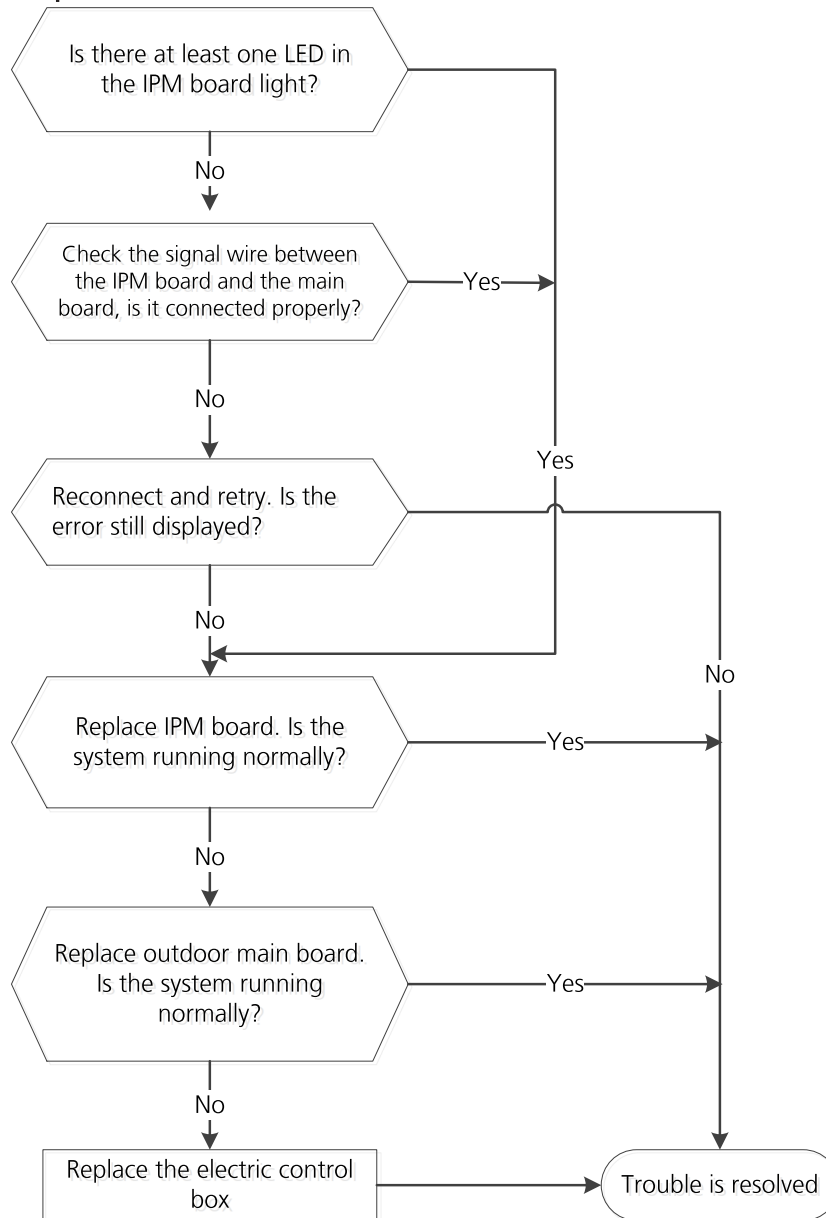

6.14 PC 08(Current overload protection)/PC 44(Outdoor unit zero speed protection)/ PC 46(Compressor speed has been out of control)/PC 49(Compressor overcurrent failure) diagnosis and solution

Description: An abnormal current rise is detected by checking the specified current detection circuit.

Recommended parts to prepare:

- Connection wires
- Rectifier
- PFC circuit or reactor
- Blocked refrigeration piping system
- Pressure switch
- Outdoor fan
- IPM module board
- Outdoor PCB

Troubleshooting and repair:

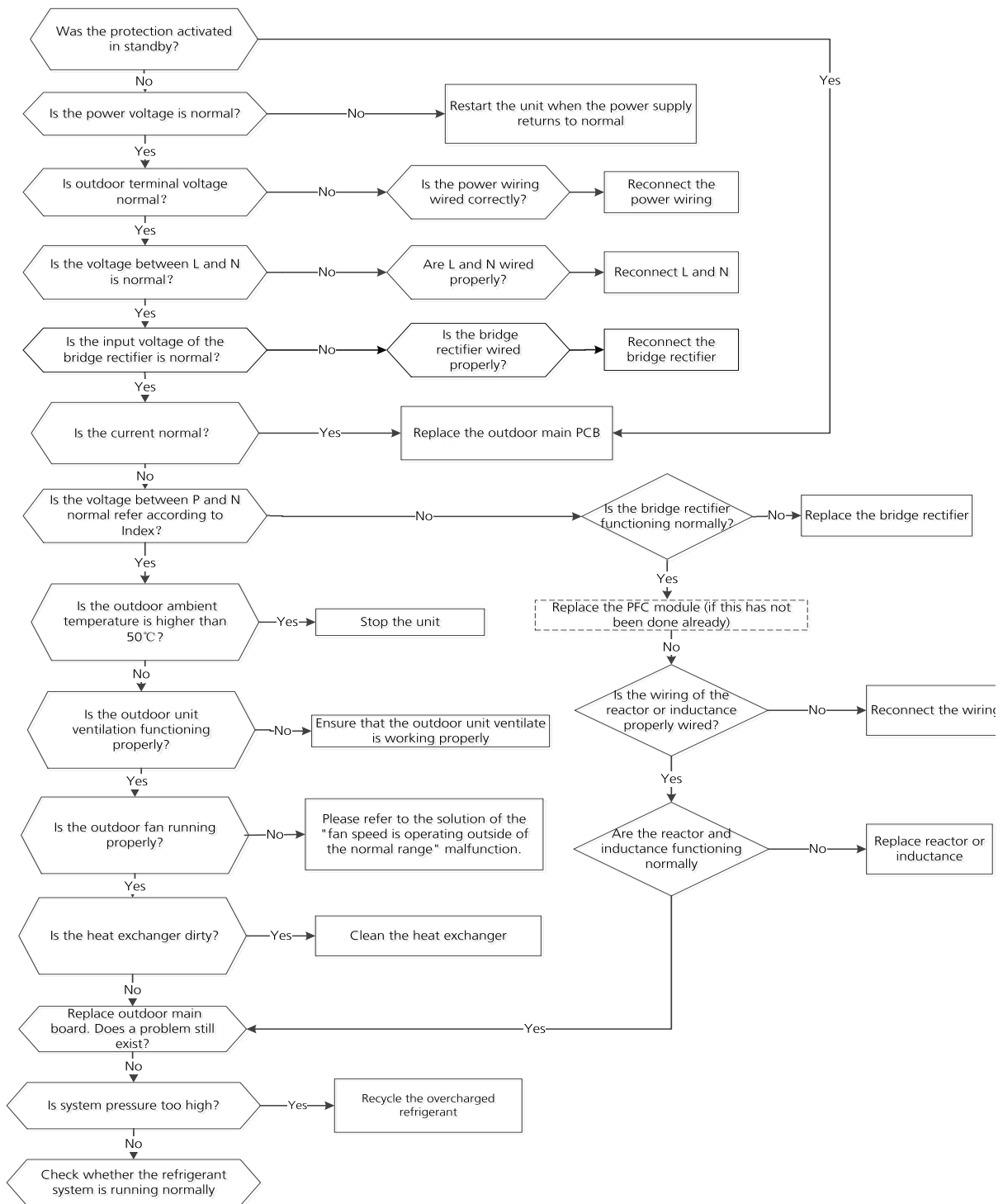

Note: For certain models, outdoor PCB could not be removed separately. In this case, the outdoor electric control box should be replaced as a whole.

6.15 PC 0F(PFC module protection diagnosis and solution)

Description: When the voltage signal that IPM send to compressor drive chip is abnormal, the LED displays the failure code and the AC turns off.

Recommended parts to prepare:

- Connection wires
- Inductance
- Outdoor main PCB
- PFC module

Troubleshooting and repair:

At first test the resistance between every two ports of U, V, W of IPM and P, N. If any result of them is 0 or close to 0, the IPM is defective. Otherwise, please follow the procedure below:

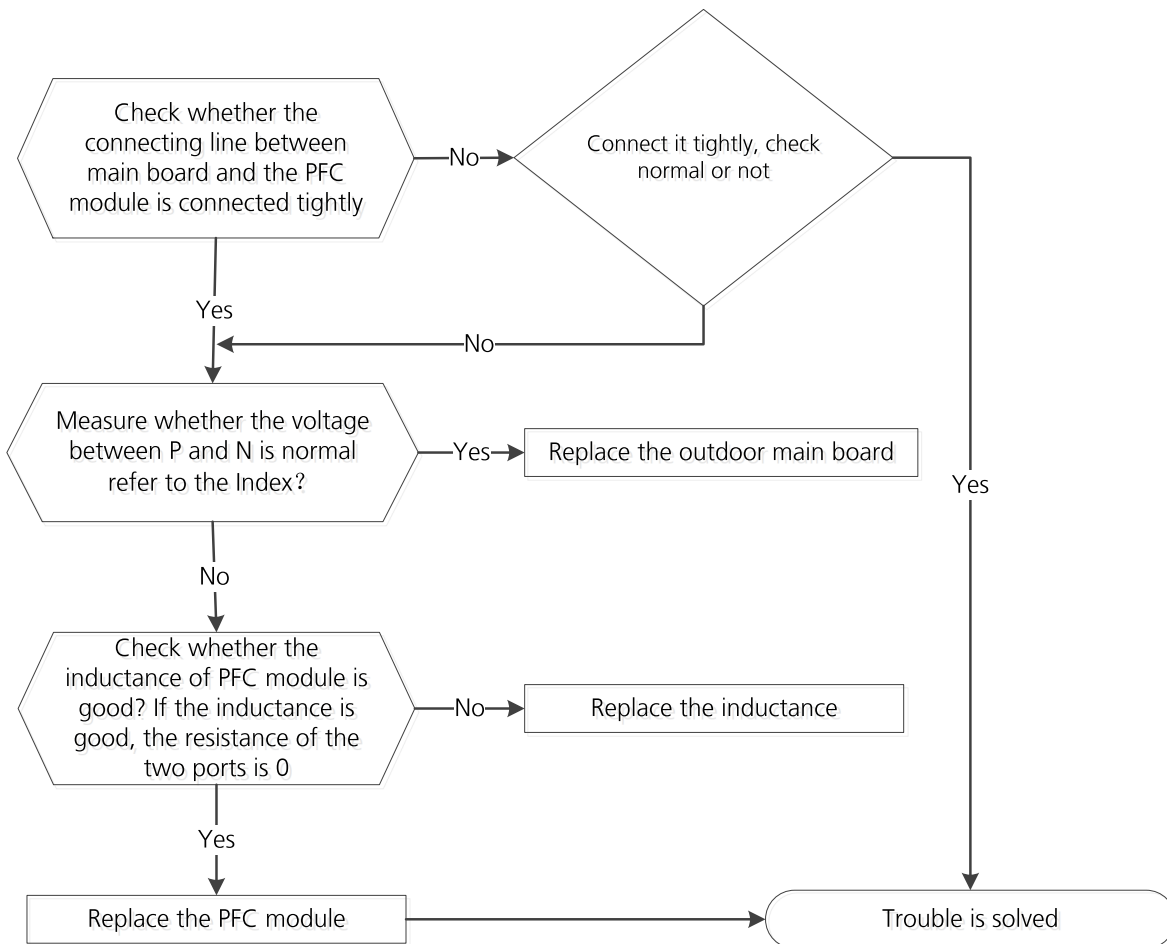

6.16 EC 72 (Lack phase failure of outdoor DC fan motor diagnosis and solution)

Description: When the three-phase sampling current of the DC motor is abnormal, especially when the current of one or more phases is always small and almost 0, the LED displays the failure code.

Recommended parts to prepare:

- Connection wire
- Fan motor
- Outdoor PCB

Troubleshooting and repair:

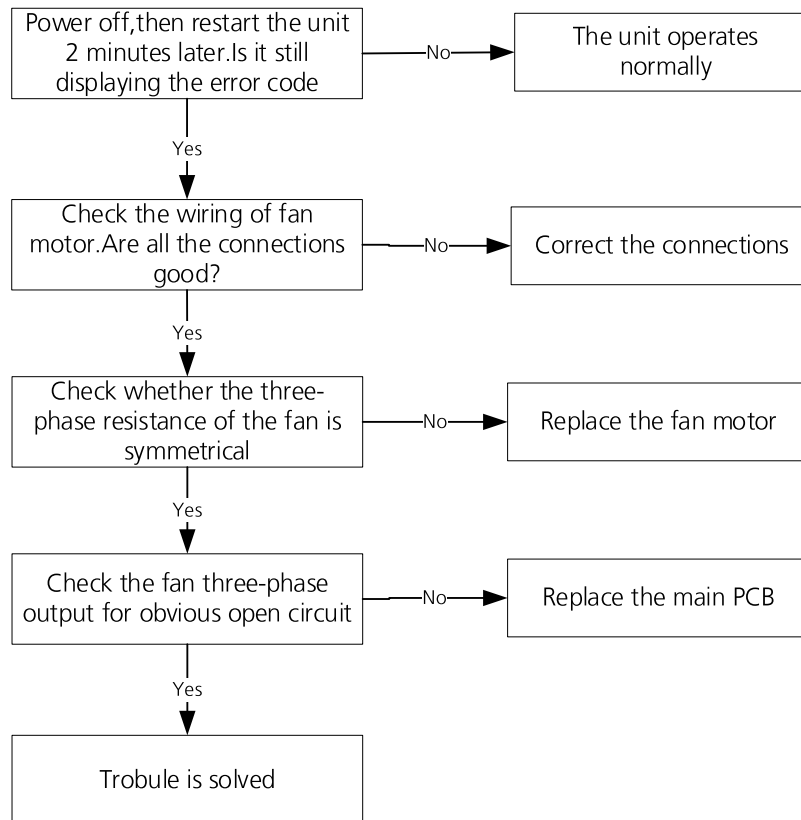

6.17 PC 43 (Outdoor compressor lack phase protection diagnosis and solution)

Description: When the three-phase sampling current of the compressor is abnormal, especially when the current of one or more phases is always small and almost 0, the LED displays the failure code

Recommended parts to prepare:

- Connection wire
- Compressor
- Outdoor PCB

Troubleshooting and repair:

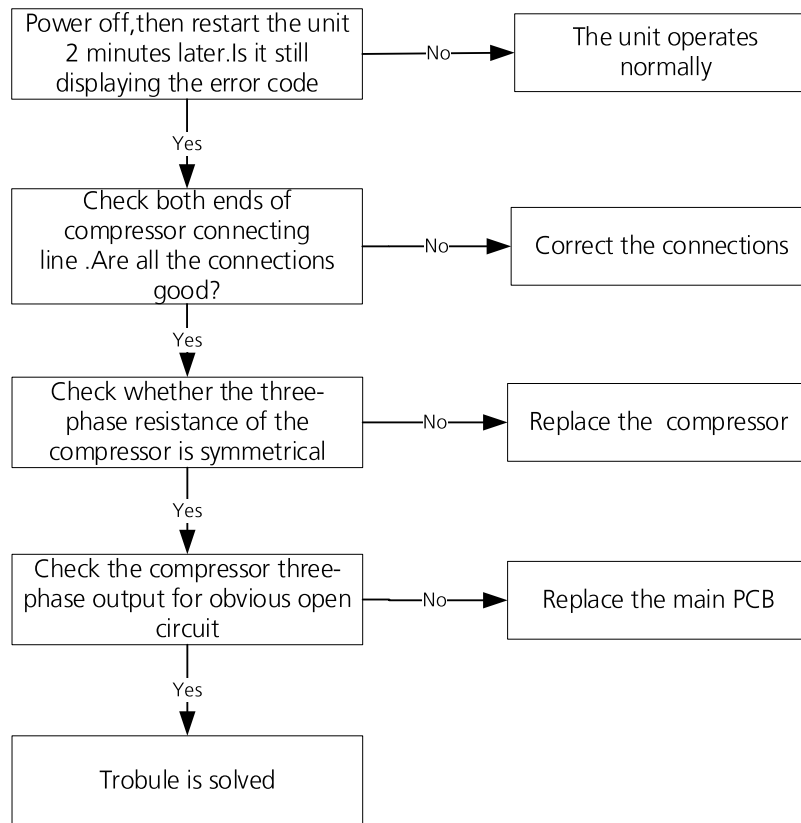

6.18 PC 45 (Outdoor unit IR chip drive failure diagnosis and solution)

Description: When the IR chip detects its own parameter error, the LED displays the failure code when power on.

Recommended parts to prepare:

- Inverter module PCB.

Troubleshooting and repair:

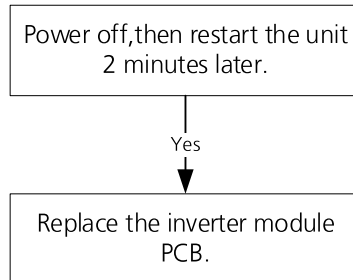

6.19 PC 0L (Low ambient temperature protection)

Description: It is a protection function. When compressor is off, outdoor ambient temperature(T4) is lower than -35°C. for 10s, the AC will stop and display the failure code.

When compressor is on, outdoor ambient temperature(T4) is lower than -40°C. for 10s, the AC will stop and display the failure code.

When outdoor ambient temperature(T4) is no lower than -32°C. for 10s, the unit will exit protection.

6.20 PC 30 (High pressure protection diagnosis and solution)

Description: Outdoor pressure switch cut off the system because high pressure is higher than 4.4 MPa

Recommended parts to prepare:

- Connection wires
- Pressure switch
- Outdoor fan
- Outdoor main PCB

Troubleshooting and repair:

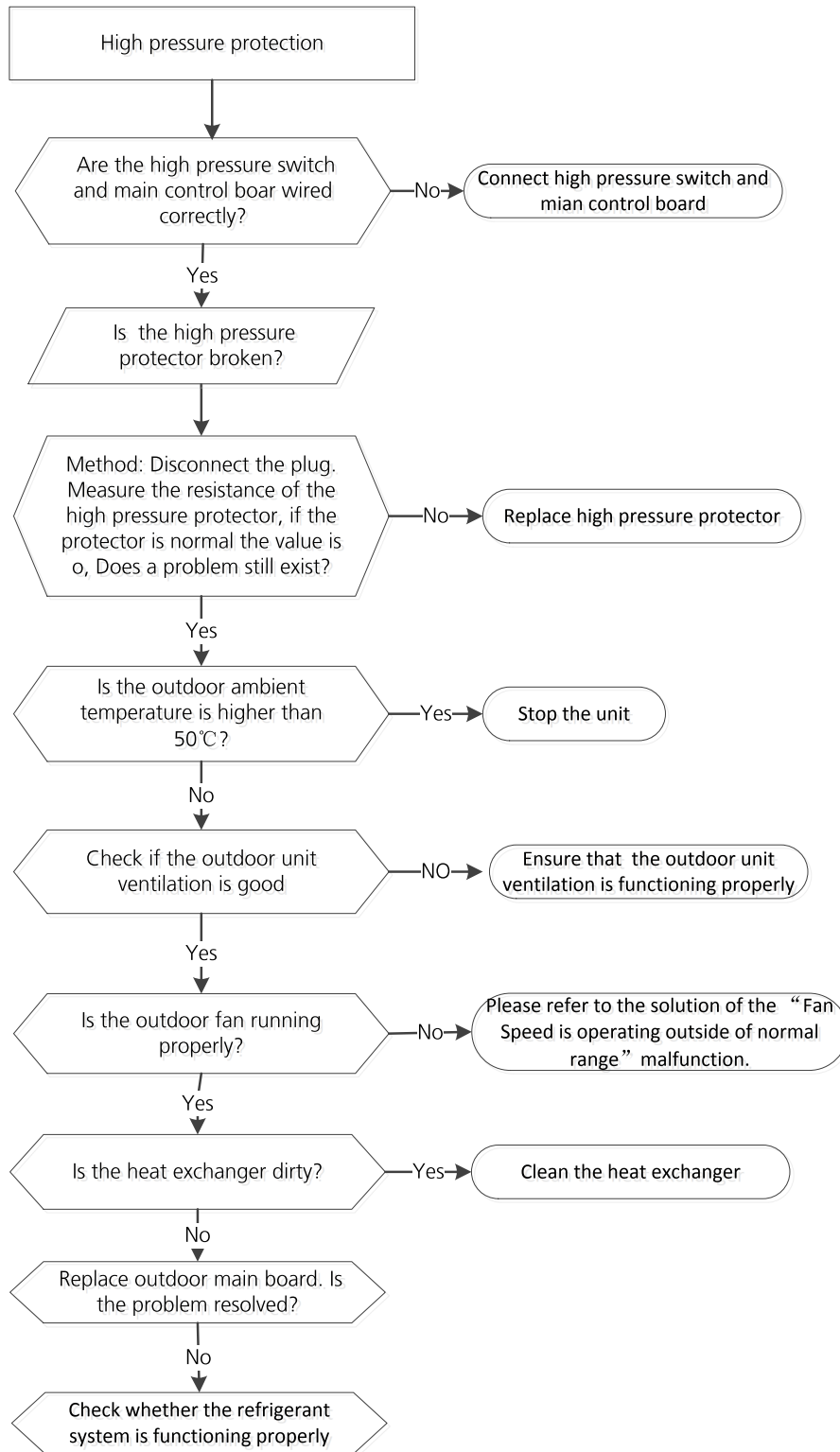

6.21 PC 0A (High temperature protection of condenser diagnosis and solution)

Description: When the outdoor pipe temperature is more than 65°C, the unit stops. It starts again only when the outdoor pipe temperature is less than 52°C.

Recommended parts to prepare:

- Connection wires
- Condenser temperature sensor
- Outdoor fan
- Outdoor main PCB
- Refrigerant

Troubleshooting and repair:

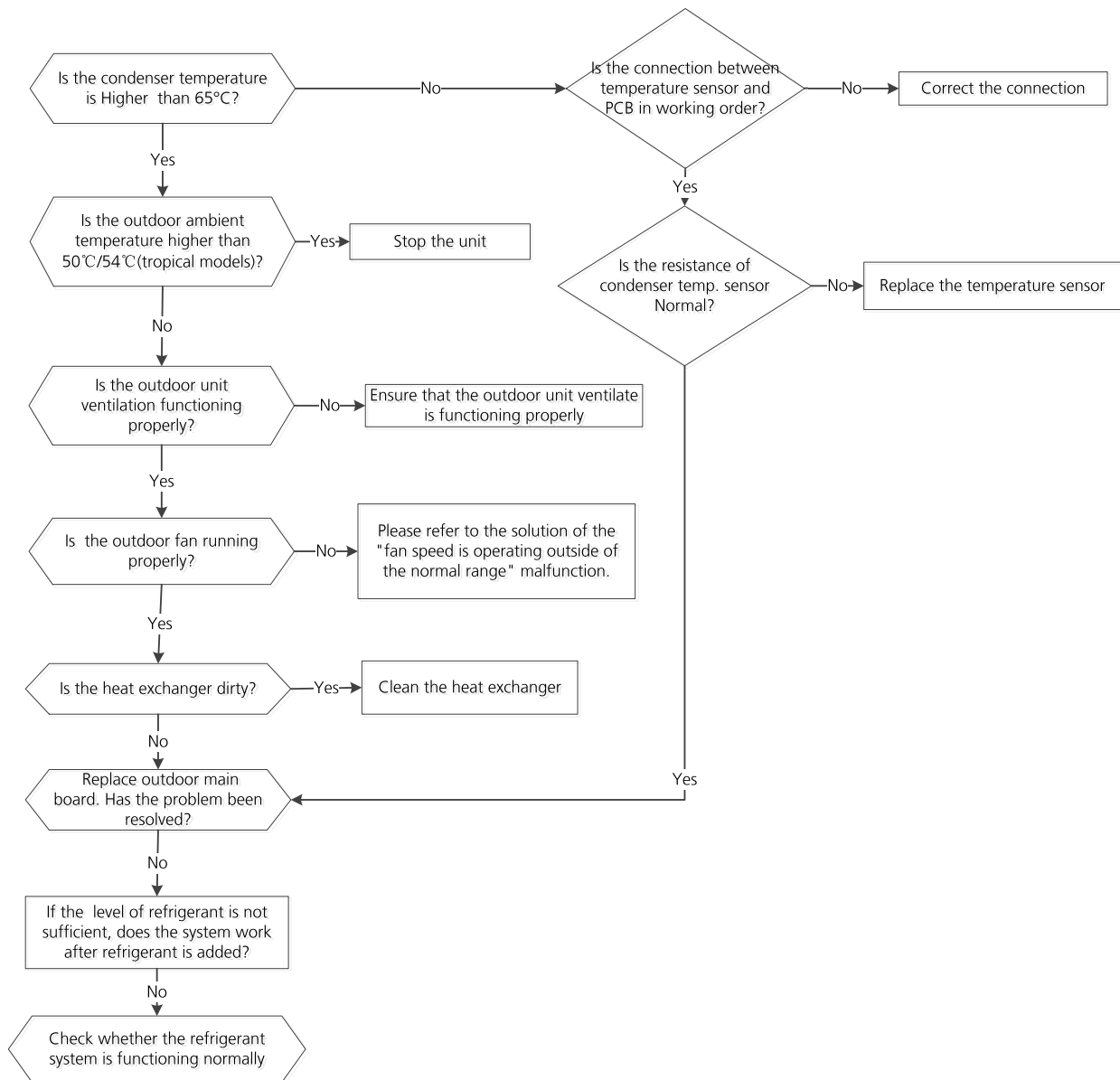

6.22 PC 06 (Discharge temperature protection of compressor diagnosis and solution)

Description: If the compressor discharge temperature exceeds a certain level for nine seconds, the compressor ceases operation, the LED displays the failure code

Recommended parts to prepare:

- Connection wires
- Discharge temperature sensor
- Additional refrigerant
- Outdoor main PCB

Troubleshooting and repair:

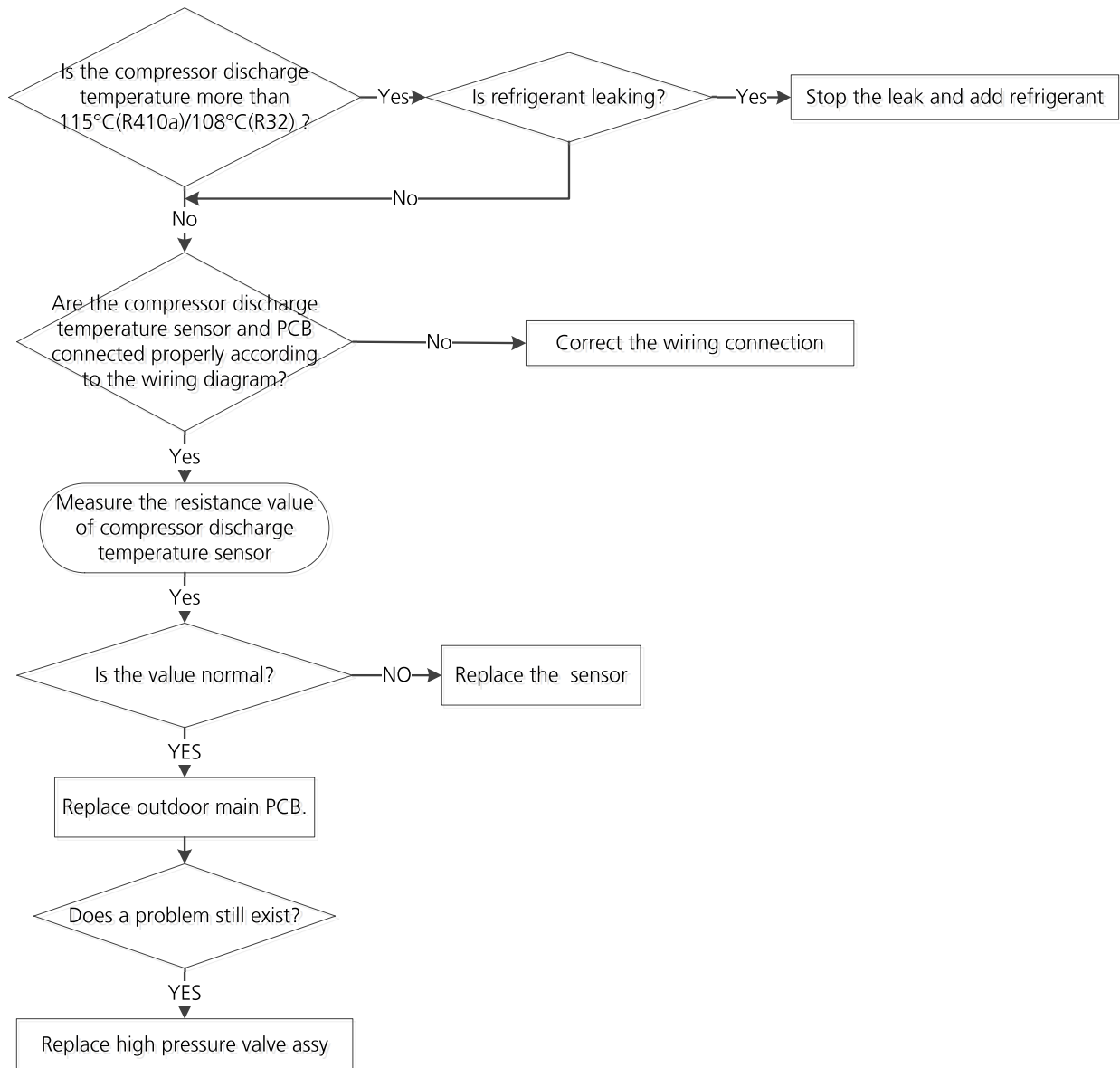

Note: For certain models, outdoor unit uses combination sensor, T3,T4 and TP are the same of sensor. This picture and the value are only for reference, actual appearance and value may vary.